

950ADVENTURE2004



BEDIENUNGSANLEITUNG

OWNER'S MANUAL
MANUALE D'USO
MANUEL D'UTILISATION
MANUAL DE INSTRUCCIONES

ART.NR: 3.210.88

The KTM logo, consisting of the letters 'KTM' in a bold, italicized, sans-serif font, is positioned in the bottom right corner of the page against an orange background.

IMPORTANT

WE STRONGLY SUGGEST THAT YOU READ THIS MANUAL CAREFULLY AND COMPLETELY BEFORE GOING ON YOUR FIRST RIDE. IT CONTAINS A GREAT DEAL OF INFORMATION AND ADVICE WHICH WILL HELP YOU USE AND HANDLE YOUR BIKE PROPERLY. IN YOUR OWN INTEREST, PLEASE PAY PARTICULAR ATTENTION TO NOTICES THAT ARE MARKED AS FOLLOWS:

△ **WARNING** △

IGNORING THESE INSTRUCTIONS, CAN ENDANGER YOUR BODY AND YOUR LIFE.

! **CAUTION** !

IGNORING THESE INSTRUCTIONS COULD CAUSE DAMAGE TO PARTS OF YOUR MOTORCYCLE OR THAT THE MOTOR-CYCLE IS NOT ROAD-SAFE ANYMORE.

Please insert the serial numbers of your motorcycle in the boxes below

Frame number

Engine number

Key number

Stamp of dealer

CONSUMER INFORMATION FOR AUSTRALIA ONLY

Tampering with noise control system prohibited

Owners are warned that the law may prohibit:

- (a) The removal or rendering inoperative by any person other than for purposes of maintenance, repair or replacement, of any device or element of design incorporated into any new vehicle for the purpose of noise control prior to its sale or delivery to the ultimate purchaser or while it is in use; and
- (b) the use of the vehicle after such device or element of design has been removed or rendered inoperative by any person.

KTM SPORTMOTORCYCLE AG RESERVES THE RIGHT TO MODIFY ANY EQUIPMENT, TECHNICAL SPECIFICATIONS, COLORS, MATERIALS, SERVICES OFFERED AND RENDERED, AND THE LIKE SO AS TO ADAPT THEM TO LOCAL CONDITIONS WITHOUT PREVIOUS ANNOUNCEMENT AND WITHOUT GIVING REASONS, OR TO CANCEL ANY OF THE ABOVE ITEMS WITHOUT SUBSTITUTING THEM WITH OTHERS. IT SHALL BE ACCEPTABLE TO STOP MANUFACTURING A CERTAIN MODEL WITHOUT PREVIOUS ANNOUNCEMENT. IN THE EVENT OF SUCH MODIFICATIONS, PLEASE ASK YOUR LOCAL KTM DEALER FOR INFORMATION.

Introduction

We would like to congratulate you on your purchase of a KTM motorcycle.

You are now the owner of a state-of-the-art sport motorcycle that guarantees to bring you lots of fun and enjoyment, provided that you clean and maintain it appropriately. **Before you go for your first ride, be sure to read this manual carefully and thoroughly in order to familiarize yourself with how to operate your new motorcycle and with its characteristics, even if this means that you will have to dedicate some of your valuable time to this task. Only by doing so will you learn how to tune your motorcycle to your specific needs and how to protect yourself against injury. Besides, this manual contains important information on motorcycle maintenance.** At the time this manual was typeset, it was up-to-date with the latest state of this production series. It cannot be completely ruled out, however, that minor discrepancies may exist resulting from further design upgrades of these motorcycles. This manual is an important part of your motorcycle and should be passed on to any subsequent owner in case you decide to sell it.

We expressly point out that work marked with an asterisk in the chapter "Maintenance work on the chassis and engine" must be performed by an authorized KTM workshop. If maintenance work should become necessary during a competition it should be performed by a trained mechanic. KTM strongly recommends that all service work to your KTM should be performed by a qualified KTM dealer.

The designations "left, right, front, rear" always refer to the direction of travel.

For your own safety, use KTM-approved parts and accessories only. KTM is not liable for damage that arises in connection with the use of other products.

Take special care to follow the recommended run in, inspection, and maintenance intervals. Heeding these guidelines will significantly increase the life of your motorcycle.

Off-road motorcycle driving is a wonderful sport and we hope that you will be able to enjoy it to the full. It may, however, involve potential problems for the environment or lead to conflicts with others. These problems or conflicts can be avoided if the motorcycle is used responsibly. To safeguard the future of motorcycle sports, make sure that you use the motorcycle in accordance with the law, show that you are environmentally conscious and respect the rights of others.

We wish you a lot of fun when driving !

KTM SPORTMOTORCYCLE AG
5230 MATTIGHOFEN, AUSTRIA

ALL RIGHTS RESERVED TO MAKE ALTERATIONS TO DESIGN AND MODEL.

© by KTM SPORTMOTORCYCLE AG, AUSTRIA All rights reserved

IMPORTANT LIMITED WARRANTY AND LIMITED GUARANTEE INFORMATION

The KTM 950 Adventure models are designed to withstand normal use on roads and easy terrain (unpaved roads).

The service, care and operating instructions for the engine and chassis specified in the owner's manual must be observed to ensure that the bike runs smoothly and to avoid premature wear.

The service work described in the "Lubrication and maintenance schedule" must be performed by an authorized KTM workshop that can verify having attended the respective training programs. Only these workshops will have trained personnel qualified to service the 950 Adventure. The service work must be recorded in the service manual, otherwise the warranty will become null and void.

The fuels and lubricants specified in the owner's manual or those of an equal quality must be used in accordance with the maintenance schedule.

The warranty or guarantee shall become void for damage and consequential damage caused by manipulations or conversions to the motorcycle.

The use of the motorcycle under extreme conditions, e.g. on extremely muddy and wet terrain, can lead to higher than average wear on components such as the drive train or the brakes. In this case it may become necessary to service or replace wear parts before the service limit specified in the maintenance schedule has been reached.



REG.NO. 12 100 6061

In accordance with the international quality management ISO 9001 standard, KTM uses quality assurance processes that lead to the highest possible product quality.

INDEX

Page	Page
	SERIAL NUMBER LOCATIONS5
	Chassis number5
	Engine number, engine type5
	OPERATION INSTRUMENTS5
	Clutch lever5
	Choke lever5
	Hand brake lever5
	Multi-functional digital speedometer6
	Display6
	Setting options in the display7
	Cooling liquid temperature display8
	Indicator lamps8
	Tachometer8
	Ignition lock9
	Combination switch9
	Emergency OFF tip switch, light switch, starter tip switch ...9
	Storage compartment10
	Filler caps10
	Seat lock10
	Fuel taps10
	Shift lever11
	Side stand11
	Center stand11
	Foot brake pedal11
	Compression damping of fork11
	Rebound damping of fork12
	Spring preload of the fork12
	Damping action during compression of shock absorber ...12
	Rebound damping of shock absorber12
	Shock absorber's preload adjuster13
	Baggage carrier plate13
	Grips13
	Footrests13
	GENERAL TIPS AND WARNINGS FOR STARTING THE MOTORCYCLE14
	Instructions for initial operation14
	Running in the LC8 engine14
	Accessories and payload14
	DRIVING INSTRUCTIONS15
	Check the following before each start15
	Starting when the engine is cold16
	Starting when the engine is warm or hot16
	Braking17
	Stopping and parking17
	Starting off17
	Shifting/Riding17
	Fuel18
	PERIODIC MAINTENANCE SCHEDULE20
	MAINTENANCE WORK ON CHASSIS AND ENGINE22
	Removing and remounting the seat22
	Tool set22
	Adjusting the fork and shock absorber23
	Adjusting compression damping of fork23
	Adjusting rebound damping of fork23
	Adjusting the spring preload on the fork23
	Compression damping of shock absorber24
	Rebound damping of shock absorber24
	Adjusting the preload of the shock absorber25

SERIAL NUMBER LOCATIONS

Chassis number

The chassis number is located on the right side of the steering head tube and on the type label. Write this number into the relevant area on page 1.

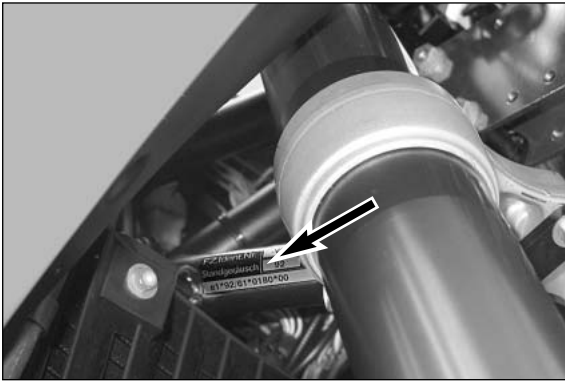

Engine number, engine type

The engine number and engine type are embossed in the engine case near the shift lever. Write this number into the relevant area on page 1.



OPERATION INSTRUMENTS

Clutch lever

The clutch lever **1** is located on the left side of the handlebar. The adjusting screw **A** is used to change the original position of the clutch lever (see maintenance work on chassis and engine).

The clutch is hydraulically actuated and adjusts itself automatically.

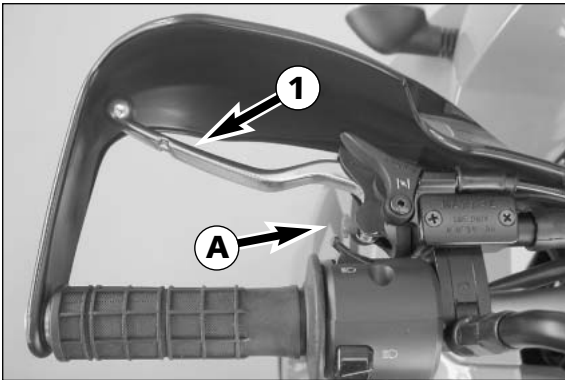

Choke lever

If the choke lever **2** is pulled backwards, a bore in the carburetors will be opened in the carburetor through which the engine may draw in additional fuel. This produces a „rich“ fuel/air mixture necessary for cold start. The fuel quantity and thus the engine speed are determined by the choke lever position.

At temperatures over 5°C (41°F) it will suffice to pull the choke lever half way out. At temperatures below 5°C (41°F) the choke lever should be pulled all the way out. The hole is closed again by pushing the choke lever all the way back in.



Hand brake lever

The hand brake lever **3** is mounted on the handlebars on the right and actuates the front wheel brake. The adjusting screw **B** can be used to change the basic position of the hand brake lever (see "Maintenance").

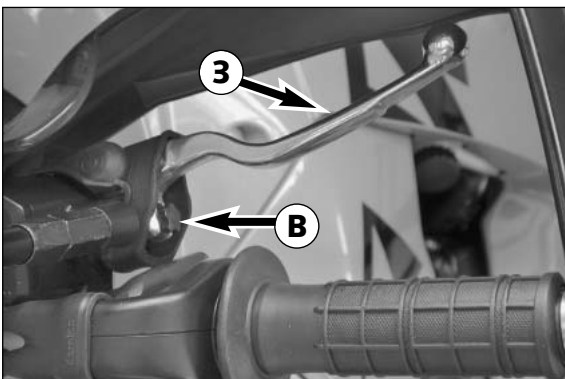

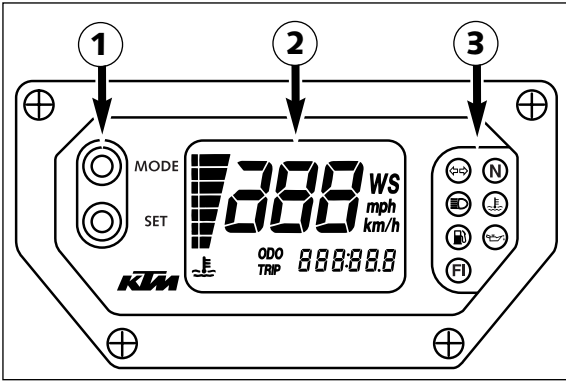

Multi-functional digital speedometer

The universal instrument is divided into 3 parts. Use the MODE and SET ① button to change the display and the basic settings in the display. Display ② shows all of the information that may be of interest to you. 5 display modes can be selected with the MODE button.

The indicator lamps ③ provide additional information on the motorcycle's running condition.

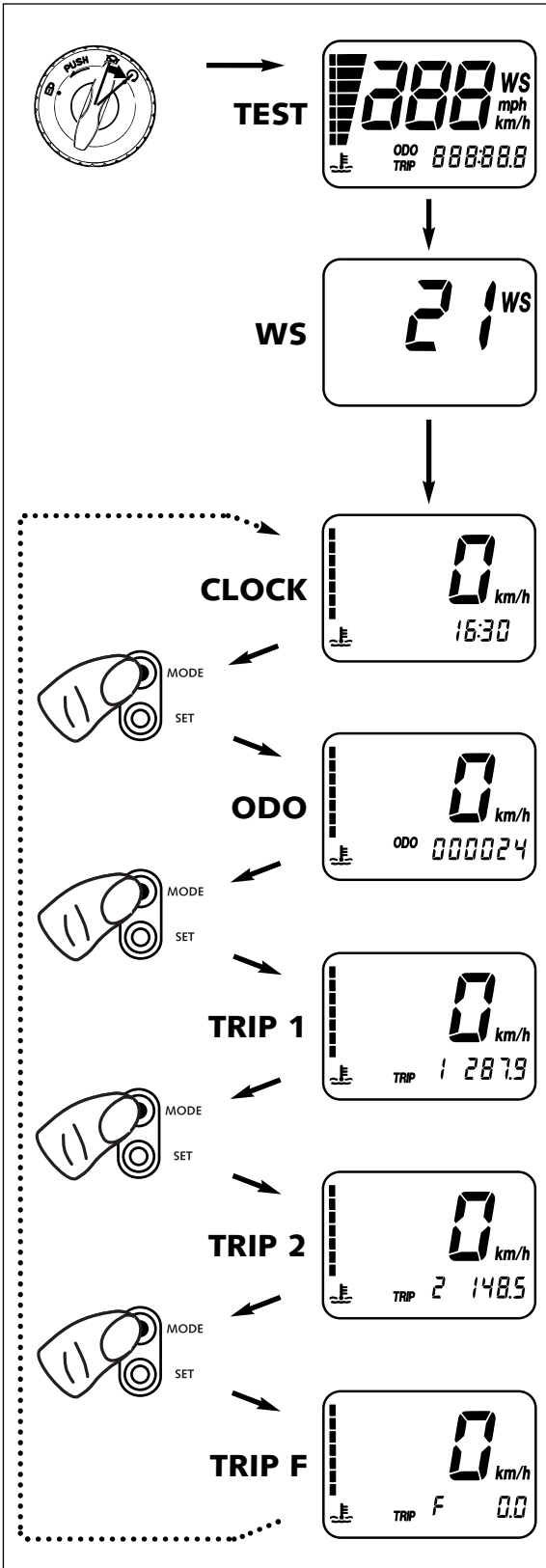

Display

TEST

When you switch on the ignition, all of the display elements will light up for 1 second for the function test.

WS (wheel size)

The display will change and show the diameter of the front wheel in inches for 1 second (WS = wheel size). Then the CLOCK mode will be displayed, or the mode that was active when the ignition was switched off.

CLOCK

You will recognize the CLOCK display by the blinking dots between the hours and minutes. It displays the speed, temperature of the cooling liquid and the clock. To switch to the next display mode, press the MODE button.

ODO

The speed, temperature of the cooling liquid and the total kilometers or miles traveled are shown in the ODO mode. To switch to the next display mode, press the MODE button.

TRIP 1

The TRIP 1 mode shows the speed, the temperature of the cooling liquid and the trip odometer 1. To switch to the next display mode, press the MODE button.

TRIP 2

The TRIP 2 mode shows the speed, the temperature of the cooling liquid and the trip odometer 2. To switch to the next display mode, press the MODE button.

TRIP F

The TRIP F (fuel) mode shows the speed, the temperature of the cooling liquid and the distance traveled since reaching the low-fuel mark (the low-fuel indicator lamp will blink). To return to the UHR mode, press the MODE button.

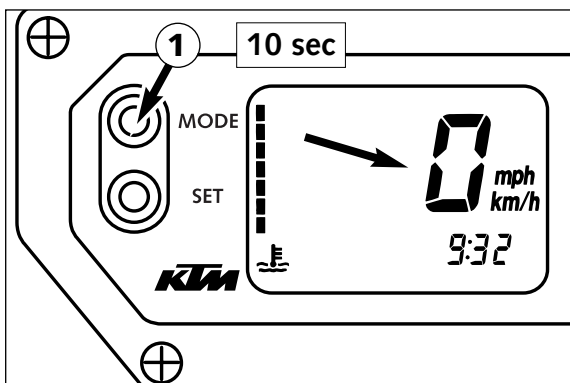

Setting options in the display

KILOMETERS OR MILES.

You can have the speed and distance shown in kilometers or miles in the display. The display can be adapted to the respective country on long-distance trips.

To switch from kilometers to miles, switch on the ignition and press the MODE ❶ button for approx. 10 seconds. The km/h display will switch to mph. The speed and the stored distances will be converted and displayed in miles.

To return to kilometers, proceed as described above.

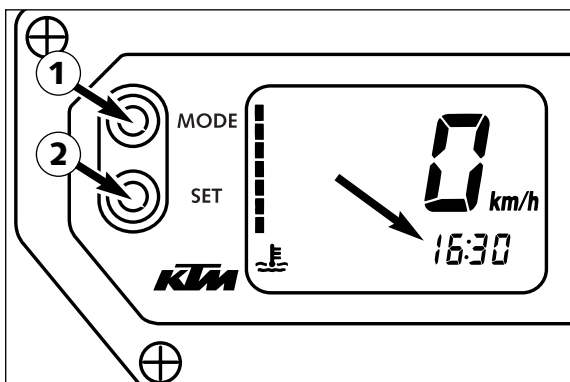

CLOCK

Switch on the ignition and change to the CLOCK mode.

Simultaneously press MODE ❶ and SET ❷. The numbers on the clock will start to blink. Use the MODE button to set the hours and the SET button to set the minutes.

To press the MODE and SET buttons simultaneously.

NOTE:

0:00 will be displayed if the clock is not supplied with electricity. This can be caused by a defective fuse or a fault in the board electric system (see Troubleshooting).

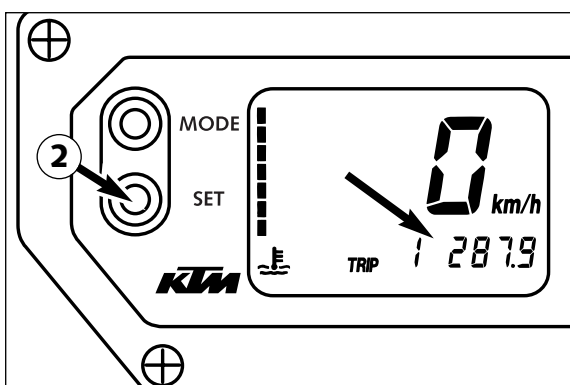

TRIP 1

The trip meter 1 runs continuously and counts up to 999.9. It can be used to measure the length of a certain route on a trip or the distance between two refueling stops.

To return the trip meter 1 to zero, switch on the ignition, change to the TRIP 1 mode and press the SET button.

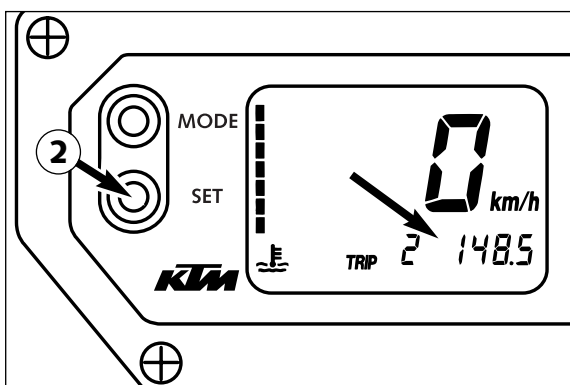

RESETTING TRIP 2

The trip meter 2 runs continuously and counts up to 999.9. It can be used similarly to TRIP 1 or together with a switch available as an accessory (see below) for trips according to a roadbook.

To return the trip meter 2 to zero, switch on the ignition, change to the TRIP 2 mode and press the SET button.

NOTE

A Tripmaster switch (Part no. 582.14.069.044) is available as an accessory and enhances the trip meter 2 functions. You can correct the displayed route by increasing or decreasing in increments of 0.1. For example, if you have taken the wrong road when driving according to a roadbook, you can easily correct the display to correspond to the roadbook again. It can also be used to change the display modes. The switch is mounted on the handlebars so that you can keep your hands on the handlebars.

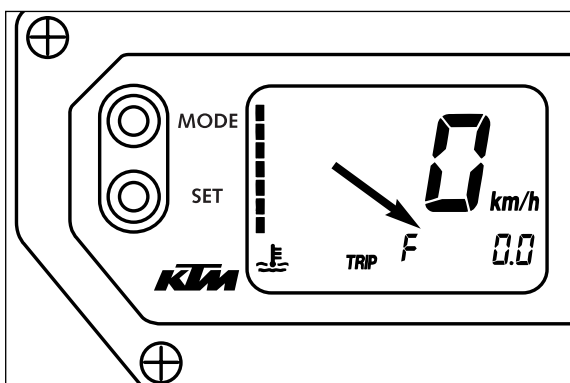

TRIP F

When the fuel level reaches the reserve mark, the display will automatically switch to TRIP F and begin to count (no matter which display mode was active before). At the same time, the fuel warning lamp will start to blink. You will still have enough reserve fuel for approx 50 kilometers (30 miles).

After refueling, it will take approx. 3 minutes for TRIP F to automatically reset to 0 and return to the previous display mode.

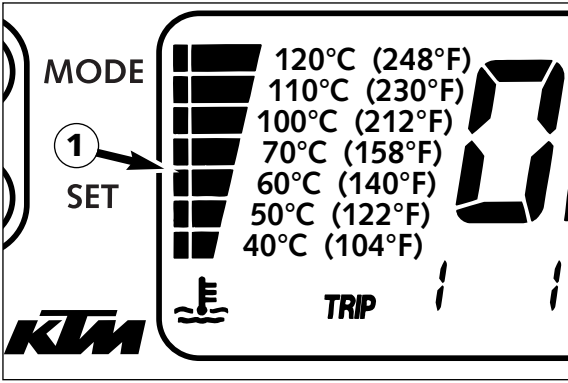

Cooling liquid temperature display

The temperature display ❶ is shown in 7 bars. The more bars that light up, the hotter the cooling liquid. When the lowest bar lights up, the cooling liquid has reached a temperature of approx. 40°C (104°F). When the upper bar lights up 120°C (248°F), all of the bars will start to blink and the red warning lamp ❷ will light up.

⚠ **WARNING** ⚠

POSSIBLE CAUSES FOR AN INCREASE IN TEMPERATURE, CAUSING THE RED WARNING LIGHT FOR THE COOLING LIQUID TEMPERATURE TO LIGHT UP:

- DRIVING TOO SLOWLY AND DRIVING WITH A HEAVY LOAD AT HIGH AIR TEMPERATURES
- NOT ENOUGH COOLING LIQUID IN THE SYSTEM
- THE VENTILATOR ON THE RADIATOR IS NOT RUNNING
- IMPROPER USE OF THE CLUTCH WHEN DRIVING SLOWLY

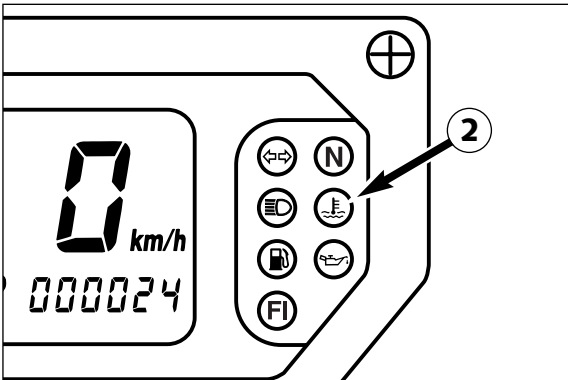

Indicator lamps

The green indicator lamp will blink in the blinker rhythm when the blinker is switched on.
NOTE:
The indicator lamp will blink slower when a blinker is broken.

The green indicator lamp will light up when the gearbox is in an idling position.

The blue indicator lamp will light up when the high beams are switched on.

The red warning light will light up when the cooling liquid has reached a temperature of approx. 120°C (248°F).

The orange warning light will start to blink when the fuel level has reached the reserve mark. At the same time the display will automatically change to TRIP F (see TRIP F).

The red warning lamp lights up when the ignition is switched on but the engine is not running. When the engine is started, the warning lamp will go out as soon as the oil pressure is high enough.

This indicator lamp has no function.

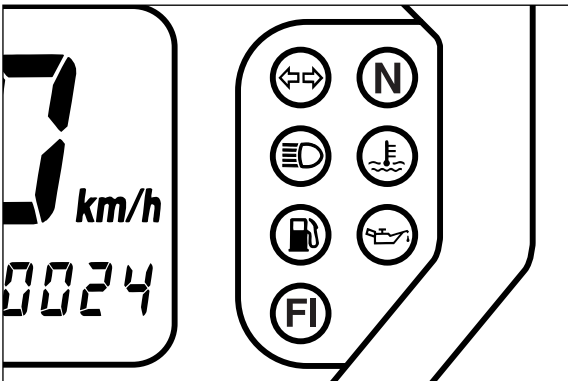

Tachometer

The tachometer shows the engine speed in revolutions per minute. Do not run the engine beyond the black mark at 9500 rpm.

The speed limiter will set in at 9600 rpm, drastically reducing the engine power above this rotational speed.

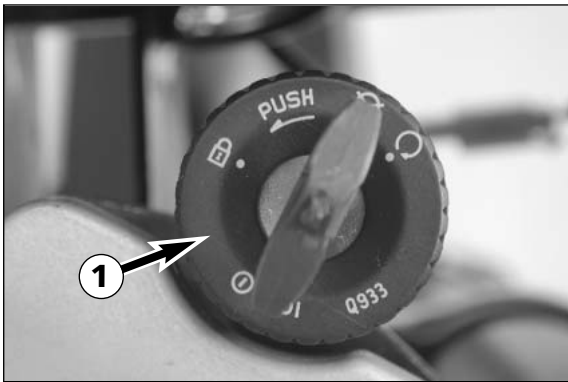

Ignition lock

The ignition lock ❶ has 3 switching positions.

- ❌ Ignition off, (engine can't be started)
- ⊙ Ignition on, (engine can be started)
- 🔒 Ignition off, handlebar blocked
To switch the ignition to position ⊙ turn the ignition key to position ❌ and firmly press it into the lock. Turn the handlebar all the way to the left, then turn the ignition key to the left.

The ignition key can be withdrawn in position ❌ and ⊙.

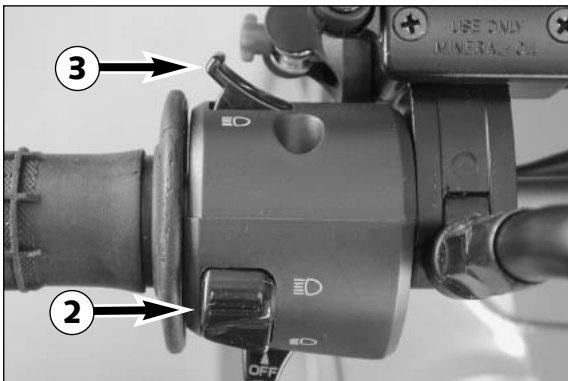

Combination switch

The rocker switch LIGHTS ❷ actuates the high beam or low beam.

- ☰⊙ = High-beam light
- ☷⊙ = Low-beam light
- ☰⊙ The light signal (high beam) is actuated with button ❸.

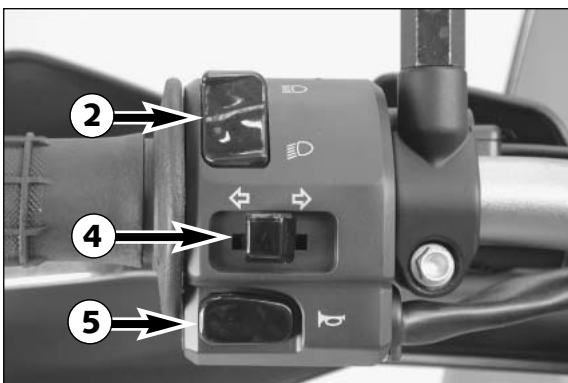

↔ The indicator switch ❹ returns to central position after actuation. Press flasher switch towards switch housing to switch off the flasher.

🔊 The horn is sounded with button ❺.

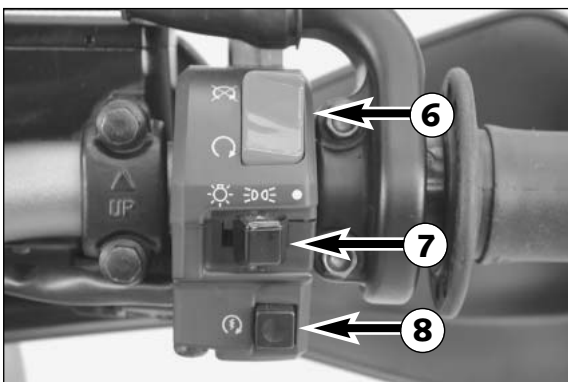

Emergency OFF tip switch, light switch, starter tip switch

The emergency off switch ❻ is provided for emergency situations and should not be used to switch off the engine.

The engine is ready for operation in position ⊙ (ignition circuit and starter circuit are switched on).

The engine cannot be started in position ❌ (ignition circuit and starter circuit are interrupted).

The light switch ❼ has 3 positions:

- = Light off
- ☰☷ = Parking light on
- ☀ = Headlight on

⚡ Use the starter tip switch ❸ to operate the electric starter.

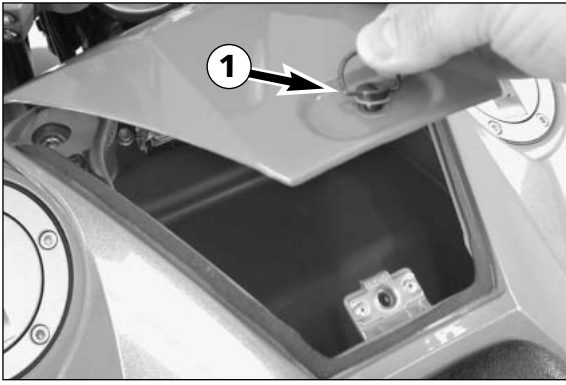

Storage compartment

A storage compartment is located under the seat to hold small, frequently used items.

To open, turn the quick release **1** approx. 180° in a counterclockwise direction and lift the cover. To lock, close the cover, insert the quick release in the dolly and turn 180° in a clockwise direction.

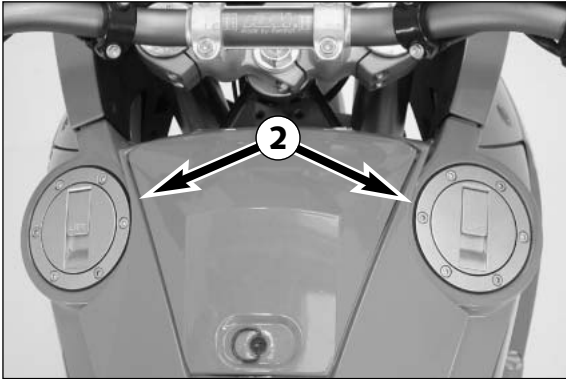

Filler caps

The 950 Adventure has 2 separate fuel tanks.

Both filler caps **2** can be locked and are equipped with a tank vent system. To open, insert the ignition key, turn 45° in a clockwise direction and fold up the filler cap.

The ignition key can be pulled out to open the other filler cap. Simply press on the filler cap to close.

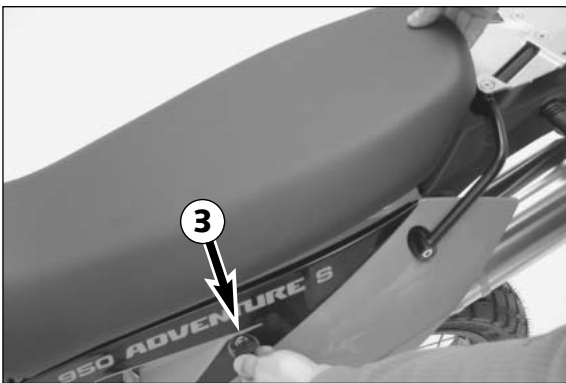

Seat lock

The seat is unlocked by inserting the ignition key in the lock **3** on the side and turning the key in a counterclockwise direction. See "Maintenance Work" to remove and remount the seat.

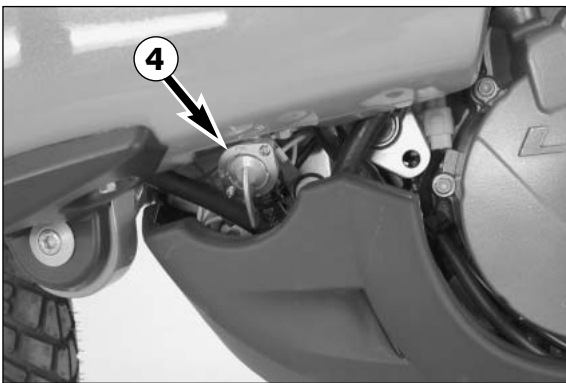

Fuel taps

The 950 Adventure is equipped with 3 fuel taps which only need to be closed to remove the fuel tank.

Fuel cannot flow to the carburetors if the fuel pump is not running, so the fuel tap **4** does not need to be closed when the motorcycle is switched off.

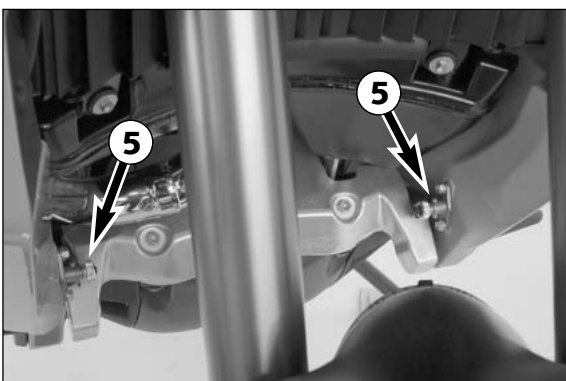

Both fuel taps **5** must be open when the motorcycle is running. The level in the fuel tanks is equalized by means of a connecting hose.

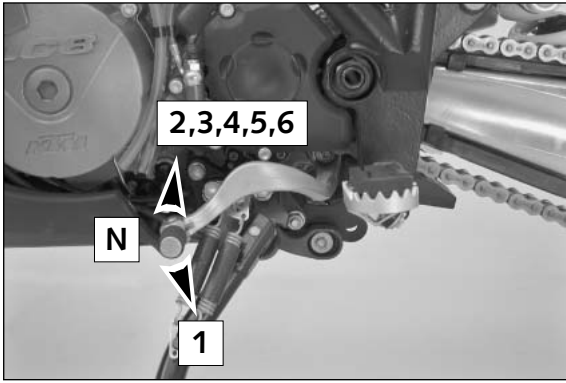

Shift lever

The shift lever is mounted on the left side of the engine. The position of the gears is shown in the illustration. Neutral, or the idle speed, is located between first and second gear.

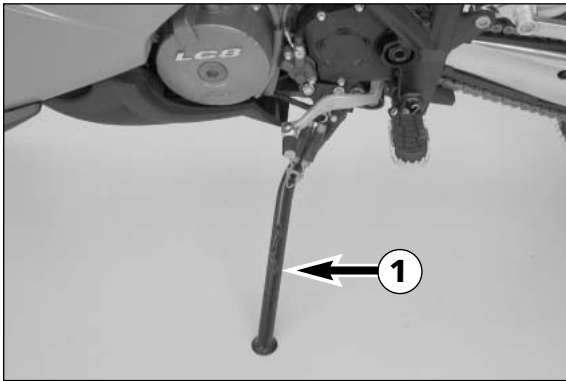

Side stand

The side stand ① is coupled with a safety starter system. Pay attention to Driving Instructions.

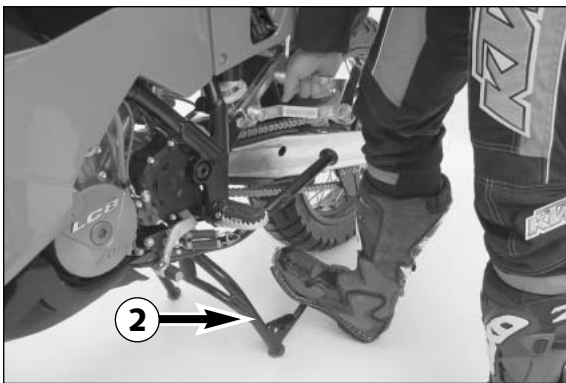

Center stand

The bike is equipped with a side stand and a center stand ②.

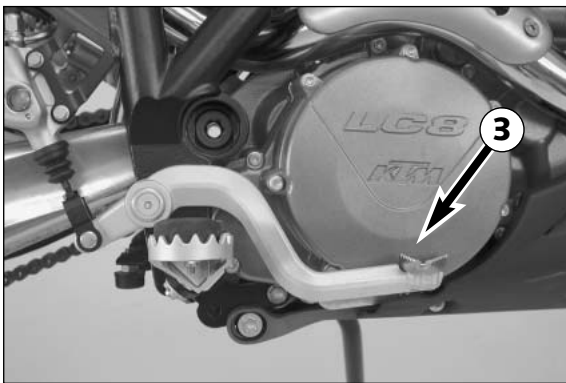

Foot brake pedal

The foot brake pedal ③ is located in front of the right footrest. Its basic position can be adjusted to your seat position (see maintenance work).

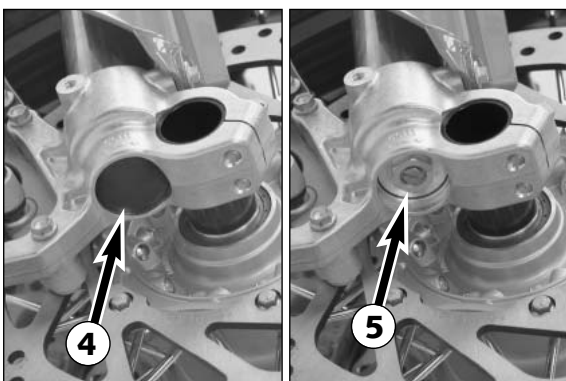

Compression damping of fork

The fork's damping action during compression travel (compression damping) can be adjusted. This allows you adjust the damping behavior to match your driving style and the payload.

The adjusting screws ⑤ are located under the cap ④ on the lower end of the fork legs.

More information is provided in the chapter "Adjusting the fork and shock absorber."

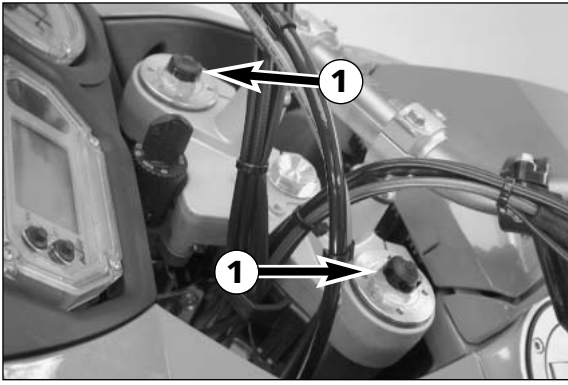

Rebound damping of fork

The fork's damping action during rebound travel (rebound damping) can also be adjusted. This allows you adjust the damping behavior to match your driving style and the payload. The adjusting screws ① are located on the upper end of the fork legs. More information is provided in the chapter "Adjusting the fork and shock absorber."

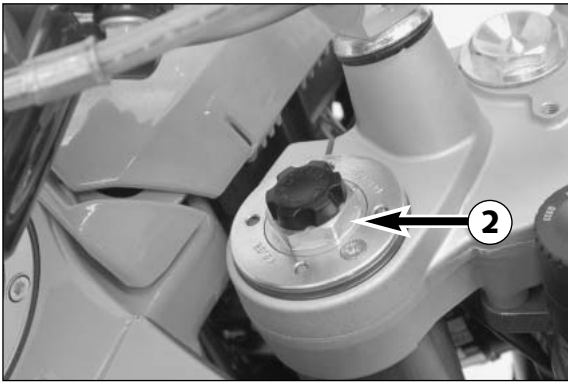

Spring preload of the fork

The fork's preload can be adjusted by means of the adjusting screws ②. More information is provided in the chapter "Adjusting the fork and shock absorber."



Damping action during compression of shock absorber

The shock absorber's damping action during compression travel (compression damping) can be adjusted. This allows you adjust the shock absorber's damping behavior to match your driving style and the payload. The damping rate can be adjusted in the low and high-speed range (Dual Compression Control). The designation low and high-speed refers to the movement of the shock absorber and not to the motorcycle's driving speed.

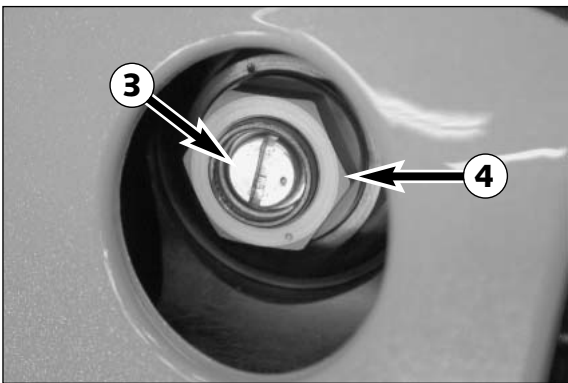

The adjusting screw ③ for the low-speed range can be adjusted with a screwdriver.

The adjusting screw ④ for the high-speed range can be adjusted with a 17 mm socket wrench.

More information is provided in the chapter "Adjusting the fork and shock absorber."

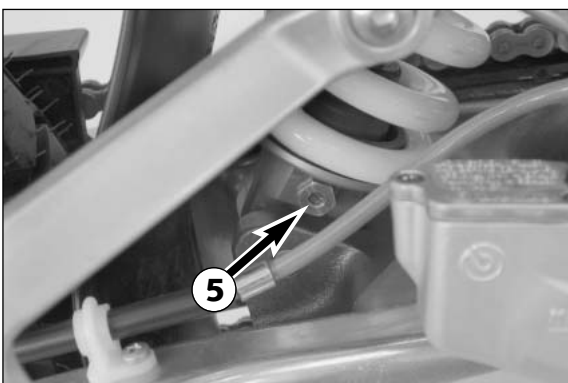

Rebound damping of shock absorber

The shock absorber's damping action during rebound travel (rebound damping) can also be adjusted. This allows you adjust the damping behavior to match your driving style and the payload. The adjusting screw ⑤ is located on the bottom of the shock absorber. More information is provided in the chapter "Adjusting the fork and shock absorber."

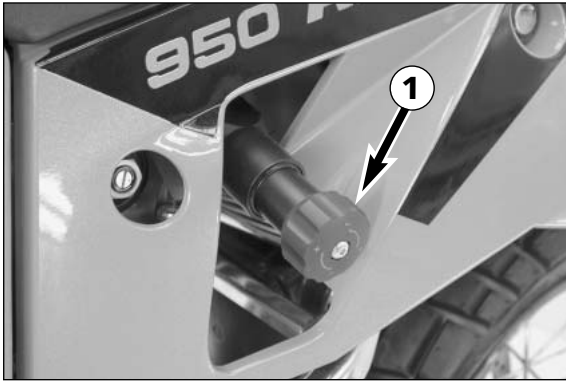

Shock absorber's preload adjuster

The shock absorber's preload adjuster is infinitely variable by means of the hand wheel ❶. This allows the shock absorber to be adapted to match your body weight and the payload.
The hand wheel can be swung out to make adjustments.

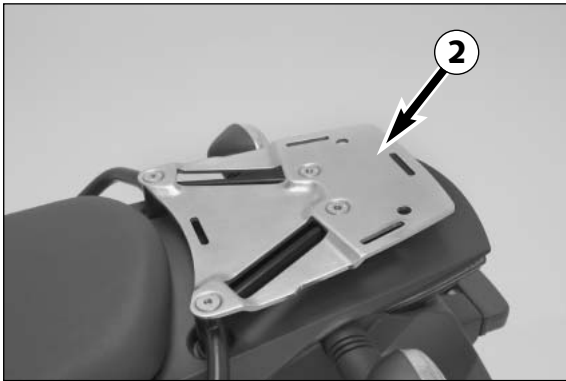

Baggage carrier plate

The base plate for your choice of case system can be attached to the baggage carrier plate ❷.



WARNING



- DO NOT LOAD MORE THAN 8 KG ON THE TRUNK CARRIER RACK.
- OBSERVE THE BAGGAGE MANUFACTURER'S INSTRUCTIONS.

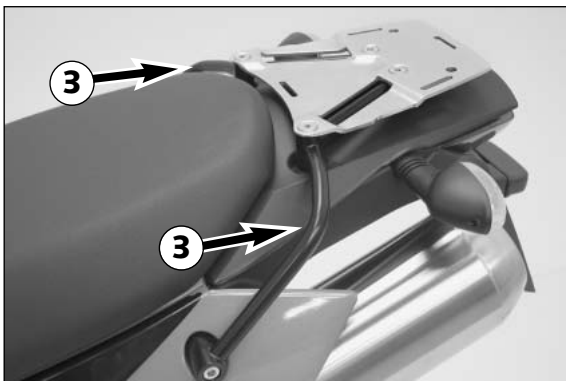

Grips

The passenger can hold on to both grab handles ❸.

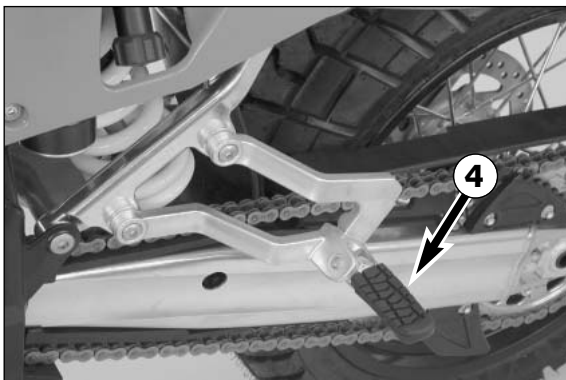

Footrests

The passenger footrests ❹ fold up.

GENERAL TIPS AND WARNINGS FOR STARTING THE MOTORCYCLE

Instructions for initial operation

- Verify that your KTM dealer performed the PREPARATION OF VEHICLE jobs (see Customer Service Manual).
- Read these operating instructions carefully before your first ride.
- Enter the chassis, engine and key numbers on page 1.
- Familiarize yourself with the operating elements.
- Adjust the hand brake lever and foot brake lever to your most comfortable position.
- This motorcycle is equipped with 2 catalytic converters. Leaded fuel will destroy the catalytic converters. Please use unleaded fuel only.
- Get used to handling the motorcycle on an empty parking lot, before starting on a longer drive. Also try to drive as slowly as possible and in standing position, to improve your feeling for the vehicle.
- Do not drive along off-road tracks which go beyond your ability and experience.
- Hold the handlebars with both hands and leave your feet on the foot rests while driving.
- Remove your foot from the foot brake lever when you are not braking. If the foot brake lever is not released the brake pads rub continuously and the braking system is overheated.
- Do not make any alterations to the motorcycle and always use ORIGINAL KTM SPARE PARTS. Spare parts from other manufacturers can impair the safety of the motorcycle.
- Motorcycles are sensitive to changes in the weight distribution. Read the section on "Accessories and payload" when carrying luggage.
- Pay attention to running-in procedure.

Running in the LC8 engine

Even finely machined surfaces of engine parts have rougher surfaces than parts that slide on each other for a long time. Therefore, every engine must be run in. For this reason, do not demand maximum performance from the engine for the first 1000 kilometers (620 miles). The vehicle must be run in at low, changing performance level for the first 1000 KM (620 miles). The maximum number of revolutions per minute must not go exceed 6500 rpm. Once you have run your engine in for 1000 km, you may push it to its 9500 rpm limit, i.e. up to the red zone indicated in the tachometer. Exceeding the above listed rotations as well as pushing high rpm when the engine is cold will have an adverse effect on the life of your engine.



WARNING



- WEAR SUITABLE CLOTHING WHEN DRIVING A MOTORCYCLE. CLEVER KTM DRIVERS ALWAYS WEAR A HELMET, BOOTS, GLOVES AND A JACKET, REGARDLESS OF WHETHER DRIVING ALL DAY OR JUST FOR A SHORT TRIP. THE PROTECTIVE CLOTHING SHOULD BE BRIGHTLY COLORED SO THAT OTHER VEHICLE CAN SEE YOU AS EARLY AS POSSIBLE. YOUR PASSENGER WILL ALSO NEED SUITABLE PROTECTIVE CLOTHING.
- DO NOT DRIVE AFTER HAVING CONSUMED ALCOHOL.
- ALWAYS TURN ON THE LIGHT TO MAKE SURE THAT OTHER DRIVERS BECOME AWARE OF YOU AS EARLY AS POSSIBLE.
- DRIVE AT A MODERATE SPEED FOR THE FIRST FEW KILOMETERS OF EACH TRIP TO ALLOW THE TIRES TO REACH THE NECESSARY OPERATING TEMPERATURE. MAXIMUM ROAD GRIP IS ASSURED WHEN THE TIRES ARE WARM.
- THE FRONT AND REAR WHEEL ARE ALLOWED TO BE FITTED ONLY WITH TIRES THAT HAVE THE SAME PROFILE TYPE.
- THE TIRES MUST BE DESIGNED FOR A MAXIMUM SPEED OF 240 KPH (SPEED SYMBOL V) AND MUST BE AUTHORIZED BY KTM.
- DO NOT EXCEED THE RESPECTIVE MAXIMUM SPEED FOR TIRES DESIGNED WITH A SPEED INDEX OF LESS THAN "V" (240 KPH). A STICKER SHOWING THE MAXIMUM SPEED MUST BE AFFIXED TO THE MOTORCYCLE WITHIN THE DRIVER'S FIELD OF VISION.



WARNING



- NEW WHEELS HAVE A SMOOTH SURFACE, WHICH MEANS THAT THEY MUST BE RUN IN TO ACHIEVE FULL GRIP. FOR THIS PURPOSE, RIDE THE MOTORCYCLE CAREFULLY AT MODERATE SPEED DURING THE FIRST 200 KILOMETERS WITH NEW TIRES, TILTING THE VEHICLE AT DIFFERENT ANGLES SO THAT ALL SECTIONS ARE PROPERLY ROUGHENED. TIRES WILL NOT DISPLAY THEIR FULL GRIP CHARACTERISTICS UNTIL THEY ARE PROPERLY RUN IN.
- WHEELS WITH A DIFFERENT RIM DIAMETER OR OTHER RIM WIDTH MAY NOT BE MOUNTED OTHERWISE THE VEHICLE HANDLING WILL NO LONGER BE SAFE.
- OBSERVE THE TRAFFIC REGULATIONS, DRIVE DEFENSIVELY AND TRYING TO LOOK AHEAD AS FAR AS POSSIBLE SO THAT ANY HAZARDS CAN BE RECOGNIZED AS EARLY AS POSSIBLE.
- CHOOSE YOUR DRIVING SPEED ACCORDING TO THE CONDITIONS AND YOUR DRIVING SKILLS.
- DRIVE CAREFULLY ON UNKNOWN ROADS OR ON UNFAMILIAR TRIALS.
- RENEW THE VIZOR ON YOUR HELMET OR THE GLASS OF YOUR GOGGLES ON TIME SO AS TO ENSURE OPTIMUM VISION IN ANY SITUATION. WHEN LIGHT SHINES DIRECTLY ON SCRATCHED VISOR OR GOGGLES, THE OPERATOR WILL BE BLINDED.
- NEVER LEAVE YOUR MOTORCYCLE WITHOUT SUPERVISION IF THE ENGINE IS RUNNING.

Accessories and payload

Accessory parts and baggage can significantly decrease a motorcycle's driving stability. Please observe the following warnings.



WARNING



- NEVER DRIVE FASTER THAN 130 KPH (80 MPH) IF YOU HAVE MOUNTED ACCESSORY PARTS ON YOUR MOTORCYCLE. ACCESSORY PARTS CAN SIGNIFICANTLY IMPAIR THE MOTORCYCLE'S HANDLING, ESPECIALLY IN THE MAXIMUM SPEED RANGE.
- NEVER DRIVE FASTER THAN 130 KPH (80 MPH) IF YOUR MOTORCYCLE IS LOADED WITH CASES OR OTHER BAGGAGE. THEY WILL IMPAIR THE MOTORCYCLE'S HANDLING AT HIGHER SPEEDS AND CAN EASILY CAUSE IT TO GO OUT OF CONTROL.
- IF YOU HAVE CASES MOUNTED, DO NOT EXCEED THE MANUFACTURER'S RECOMMENDED MAXIMUM PAYLOAD.
- FASTEN THE BAGGAGE CLOSE TO THE CENTER OF THE MOTORCYCLE AND DISTRIBUTE THE WEIGHT EVENLY ON THE FRONT AND REAR WHEELS AND ON THE LEFT AND RIGHT.
- BAGGAGE MUST BE SECURELY AND ADEQUATELY FASTENED; LOOSE BAGGAGE WILL SIGNIFICANTLY IMPAIR DRIVING SAFETY.
- A HIGH PAYLOAD WILL CHANGE THE MOTORCYCLE'S HANDLING AND CONSIDERABLY INCREASE THE BRAKING DISTANCE; ADAPT YOUR DRIVING SPEED ACCORDINGLY.



Check the following before each start

When you start, the motorcycle must be in perfect mechanical condition. For safety reasons, you should make a habit of performing an overall check of your motorcycle before each start.

The following checks should be performed:

- 1 FUEL**
Check the fuel quantity in the tanks.
- 2 CHAIN**
A loose chain can fall from the chain wheels; an extremely worn chain can tear, and insufficient lubrication can result in unnecessary wear of chain and chain wheels.
- 3 TIRES**
Check for damaged tires. Tires showing cuts or dents must be replaced. The tread depth must comply with the legal regulations. Also check the air pressure. Insufficient tread and incorrect air pressure deteriorate the driving performance.
- 4 BRAKES**
Check correct functioning of the braking system. Check for sufficient brake fluid in the reservoir. The reservoirs have been designed in such a way that brake fluid does not need to be refilled even when the brake pads are worn. If the level of brake fluid falls below the minimum value, this indicates a leak in the braking system or completely worn out brake pads. Arrange for the braking system to be checked by a KTM specialist, as complete failure of the braking system can be avoided. Also check the state of the brake hose and the thickness of the brake linings. Check free travel at hand brake lever and foot brake lever.
- 5 CABLES**
Check the adjustment and smooth operation of the throttle cables and the choke cable.
- 6 COOLING FLUID**
Check the level of cooling fluid when the engine is cold.
- 7 ELECTRICAL SYSTEM**
Start the engine and check the headlight, taillight, brake light, turn signal, indicator lamps and horn for proper functioning.
- 8 CHECK OIL LEVEL**
Insufficient oil results in premature wear and consequently to engine damage.
- 9 BAGGAGE, PAYLOAD**
Never exceed the maximum total weight (400 kg, 883 lbs) and the motorcycle's wheel loads. The maximum total weight is comprised of:
 - the motorcycle in a running condition and refueled (220 kg, 485 lbs)
 - the baggage and accessories
 - the driver and passenger with protective gear and helmetAdjust the tire inflation pressure as well as the preload and damping properties of the fork and shock absorber to the total weight.
- 10 REAR MIRROR**
Sit on the motorcycle and check the adjustment of the rear mirror.



WARNING



NEVER DRIVE FASTER THAN 130 KPH (80 MPH) IF YOUR MOTORCYCLE IS LOADED WITH CASES OR OTHER BAGGAGE. THEY WILL IMPAIR THE MOTORCYCLE'S HANDLING AT HIGHER SPEEDS AND CAN EASILY CAUSE IT TO GO OUT OF CONTROL.

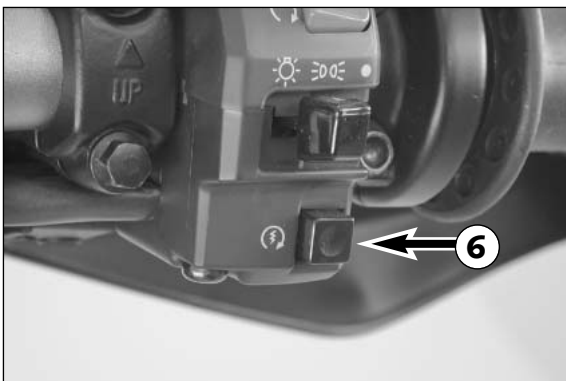
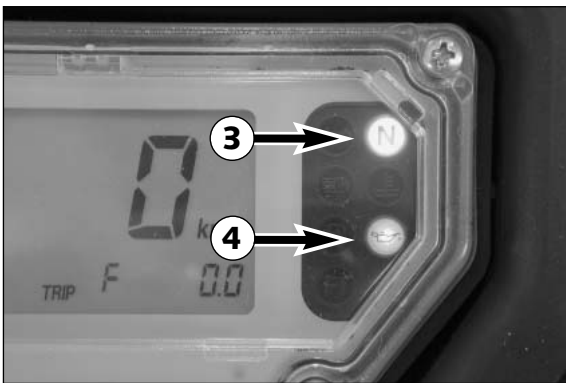
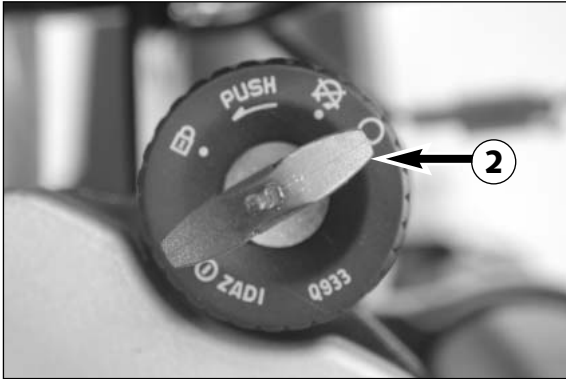
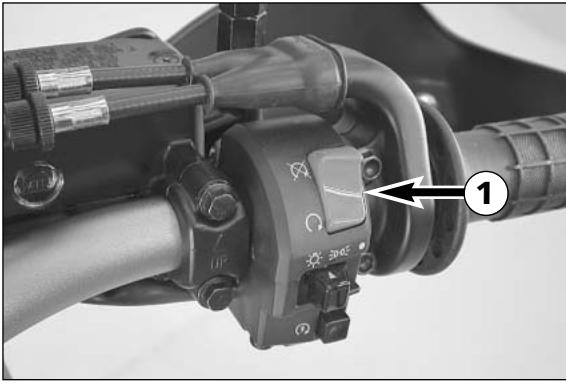

Starting when the engine is cold

- 1 Switch on emergency OFF switch ❶.
 - 2 Switch on ignition (turn ignition key ❷ into position ○).
- NOTE:
Usually the operating noise of the fuel pump can briefly be heard after the ignition is switched on.
- 3 Switch transmission to idle (green indicator lamp N ❸ lights up).
 - 4 Operate cold starting device (choke) ❹.
- Only pull the choke lever half way out at outer temperatures over 5°C (41°F). Pull the choke lever all the way out at outer temperatures below 5°C.
- 5 Do not accelerate; operate starter button ❺.
 - 6 The oil pressure warning lamp ❷ should go out as soon as the engine is running.
 - 7 Push the choke lever back in after a short time (max. 1 km, 0,6 mile).
 - 8 Take the motorcycle off of the main stand or side stand.



WARNING



DO NOT START THE ENGINE AND ALLOW IT TO IDLE IN A CLOSED ROOM. EXHAUST FUMES ARE POISONOUS AND CAN CAUSE LOSS OF CONSCIOUSNESS AND DEATH. ALWAYS PROVIDE ADEQUATE VENTILATION WHILE THE ENGINE IS RUNNING.



CAUTION



- If the OIL PRESSURE WARNING LAMP DOES NOT GO OUT AS SOON AS THE ENGINE IS RUNNING, IMMEDIATELY SWITCH OFF THE ENGINE. IF THE ENGINE IS NOT SWITCHED OFF, ENGINE DAMAGE WILL OCCUR WITHIN A SHORT PERIOD OF TIME. CHECK THE ENGINE OIL LEVEL OR CONTACT A KTM WORKSHOP.
- MAXIMUM PERIOD FOR CONTINUOUS STARTING: 5 SECONDS. WAIT AT LEAST 5 SECONDS BEFORE TRYING AGAIN.
- DON'T RIDE YOUR MOTORCYCLE WITH FULL LOAD AND DON'T REV ENGINE WHEN COLD. BECAUSE THE PISTON IS WARMING UP FASTER THAN THE WATER COOLED CYLINDER, IT CAN CAUSE ENGINE DAMAGE. ALWAYS LET THE ENGINE WARM UP BEFORE AND REFRAIN FROM DRIVING WITH FULL LOAD UNTIL THE ENGINE IS WARM.

IF THE ENGINE IS DOES NOT CRANK WHEN YOU ACTUATE THE STARTER TIP SWITCH:

- the transmission is switched to idle
- Check if the emergency OFF switch is on
- Check if the ignition is on
- the headlight is on (Light switch in ☀ position).
 - If this is not the case, the battery is discharged
 - If the lights are on, proceed as described in the „Trouble-shooting“ section or contact a KTM dealer.

IF THE ENGINE CRANKS BUT DOES NOT START, WHEN YOU ACTUATE THE STARTER TIP SWITCH:

- Check if the fuel tap is open
- Check if the choke lever has been operated
- Check if sufficient fuel is in the tank
 - If this is not the case, refill the tank
 - if sufficient fuel is in the tank, proceed as described in the „Trouble-shooting“ section or contact a KTM dealer.

NOTE:

This motorcycle is equipped with a safety starting system. The engine can only be started if the transmission is in neutral or the clutch lever is pulled. If the side stand is folded down, the engine can only be started if the transmission is in neutral or the clutch lever is pulled. The engine will stall if a gear is engaged and the clutch lever is released with the side stand folded down.

Starting when the engine is warm or hot

- 1 Switch on emergency OFF switch ❶.
- 2 Switch on ignition (turn ignition key ❷ into position ○).
- 3 Switch transmission to idle (green indicator lamp N ❸ lights up).
- 4 Do not accelerate; operate starter button ❺.
- 5 The oil pressure warning lamp ❷ should go out as soon as the engine is running.
- 6 Take the motorcycle off of the main stand or side stand.

Starting off

Turn on the light, pull the clutch lever and engage 1st gear. Slowly release the clutch lever while you open the throttle.

WARNING

- BEFORE YOU START OFF, CHECK THAT THE MAIN STAND HAS BEEN SWUNG UP FULLY. IF THE STAND DRAGS ON THE GROUND, THE MOTORCYCLE CAN GO OUT OF CONTROL.
- ALWAYS TURN ON THE LIGHT WHEN YOU DRIVE. OTHER DRIVERS WILL BE ABLE TO SEE YOU MUCH SOONER.

Shifting/Riding

You are now in first gear, referred to as the drive or uphill gear. Depending on the conditions (traffic, road gradient, etc.), you can shift to a higher gear. Close throttle, at the same time pull clutch lever and shift to the next higher gear. Let clutch lever go again and open throttle. If you turned on the choke, make sure you turn it off again as soon as engine is warm.

Only accelerate to the extent that road and weather conditions allow. Be especially careful when you accelerate in curves. Abrupt opening of the throttle can cause the motorcycle to go out of control and also increases fuel consumption.

By shifting down, use the brakes if necessary and close throttle at the same time. Pull clutch lever and shift down to the next gear. Let clutch lever go slowly and open throttle or shift down again.

If the engine is killed f.ex. at a crossing, simply pull the clutch lever and start. It is not necessary to switch the gear to NEUTRAL.

WARNING

- AVOID ABRUPT LOAD CHANGES WHILE RIDING AROUND BENDS AND ON WET OR SLIPPERY GROUND. OTHERWISE YOU MIGHT EASILY LOSE CONTROL OVER YOUR MOTORCYCLE.
- WHILE RIDING YOUR MOTORCYCLE, NEVER SWITCH THE IGNITION LOCK TO POSITIONS AND .
- DO NOT TRY TO CHANGE THE SETTINGS WHILE DRIVING. YOUR ATTENTION WILL BE DISTRACTED FROM THE TRAFFIC AND MAY CAUSE YOU TO LOSE CONTROL OF YOUR MOTORCYCLE.
- THE PASSENGER MUST HOLD ON TO THE DRIVER OR THE GRAB HANDLE ON THE BAGGAGE CARRIER DURING THE RIDE AND KEEP HIS FEET ON THE PASSENGER FOOTRESTS.
- REGULARLY MAKE SURE THAT THE BAGGAGE AND CASES ARE TIGHTLY FASTENED.
- AFTER FALLING WITH THE MOTORCYCLE, CHECK ALL FUNCTIONS THOROUGHLY BEFORE STARTING UP OPERATIONS AGAIN.
- A BENT HANDLEBAR MUST ALWAYS BE REPLACED. NEVER TRY TO STRAIGHTEN THE HANDLEBAR BECAUSE THIS WILL CAUSE IT TO LOSE ITS STABILITY.

CAUTION

- HIGH RPM RATES WHEN THE ENGINE IS COLD HAVE AN ADVERSE EFFECT ON THE LIFE OF YOUR ENGINE. WE RECOMMEND YOU RUN THE ENGINE IN A MODERATE RPM RANGE FOR A FEW MILES GIVING IT A CHANCE TO WARM UP. AFTER THAT NO FURTHER PRECAUTIONS IN THIS RESPECT NEED BE TAKEN. THE ENGINE HAS REACHED OPERATING TEMPERATURE AS SOON AS THE SECOND BAR ON THE TEMPERATURE INDICATOR LIGHTS UP.
- IF THE RED OIL PRESSURE WARNING LAMP LIGHTS UP WHILE DRIVING, THE OIL PRESSURE IS TOO LOW TO ADEQUATELY LUBRICATE THE ENGINE. STOP IMMEDIATELY AND SWITCH OFF THE ENGINE. IF YOU CONTINUE TO DRIVE, ENGINE DAMAGE WILL OCCUR WITHIN A SHORT PERIOD OF TIME. CHECK THE ENGINE OIL LEVEL OR CONTACT AN AUTHORIZED KTM WORKSHOP.
- NEVER HAVE THE THROTTLE WIDE OPEN WHEN CHANGING DOWN TO A LOWER GEAR. THE ENGINE WILL OVERSPEED, DAMAGING THE VALVES. IN ADDITION, THE REAR WHEEL BLOCKS SO THAT THE MOTORCYCLE CAN EASILY GET OUT OF CONTROL.
- NEVER USE YOUR MOTORCYCLE WITHOUT AN AIR FILTER. OTHERWISE DUST AND DIRT MAY ENTER THE ENGINE AND CAUSE INCREASED WEAR.

- STOP IMMEDIATELY IF A PERCEPTIBLE POWER LOSS OCCURS WHILE DRIVING DUE TO A DEFECTIVE IGNITION CAUSED BY A CYLINDER MISFIRING OR BREAKING DOWN. IF THE UNBURNED FUEL/AIR MIXTURE REACHES THE CATALYTIC CONVERTER, IT WILL IGNITE AND THE RESULTING HEAT WILL DESTROY THE CATALYTIC CONVERTER AND THE ADJOINING COMPONENTS.
- THE RED COOLANT WARNING LAMP LIGHTS UP WHEN THE COOLANT TEMPERATURE HAS REACHED 120°C (248°F).
POSSIBLE CAUSES FOR THE INCREASE IN TEMPERATURE:
-LOW DRIVING VELOCITY AND HIGH LOAD SITUATION IN HIGH AIR TEMPERATURES
-LEVEL OF COOLANT IN THE SYSTEM IS INSUFFICIENT
-FAN AT RADIATOR IS NOT RUNNING
-IMPROPER USE OF THE CLUTCH WHILE DRIVING AT LOW VELOCITIES
LET THE ENGINE COOL DOWN. CHECK THE COOLING LIQUID LEVEL IN THE RADIATOR - CAUTION SCALDING HAZARD! DO NOT DRIVE ON, UNTIL THERE IS SUFFICIENT LIQUID IN THE COOLING SYSTEM. HOWEVER, CALL ON ONE OF KTM'S DEALERS AS SOON AS POSSIBLE IN ORDER TO HAVE THE DEFECT REMEDIED.
- IN THE EVENT THAT, WHILE RIDING ON YOUR MOTORCYCLE, YOU NOTICE ANY UNUSUAL OPERATION-RELATED NOISE, STOP IMMEDIATELY, TURN THE ENGINE OFF, AND CONTACT AN AUTHORIZED KTM DEALER.

Braking

Close throttle and apply the hand and foot brakes at the same time. When driving on sandy, wet or slippery ground use mainly the rear wheel brake. Always brake with feeling, blocking wheels can cause you to skid or fall. Also change down to lower gears depending on your speed.

When driving downhill, use the braking effect of the engine. Change down one or two gears but do not overspeed the engine. In this way, you will not need to brake so much and the brakes will not overheat.

WARNING

- IN THE RAIN, OR AFTER THE MOTORCYCLE HAS BEEN WASHED, BRAKING ACTION MAY BE DELAYED DUE TO WET BRAKE DISCS. FIRST, THE BRAKES MUST BE BRAKED DRY.
- ON SALT-SPRAYED OR DIRTY ROADS BRAKE ACTION MAY BE DELAYED AS WELL. FIRST, THE BRAKES MUST BE BRAKED CLEAN.
- REMEMBER THAT THE STOPPING DISTANCE WILL BE LONGER IF YOU ARE CARRYING A PASSENGER OR BAGGAGE.
- WHEN YOU BRAKE, THE BRAKE DISCS, BRAKE PADS, BRAKE CALIPER AND BRAKE FLUID HEAT UP. THE HOTTER THESE PARTS GET, THE WEAKER THE BRAKING EFFECT. IN EXTREME CASES, THE ENTIRE BRAKING SYSTEM CAN FAIL.

Stopping and parking

Apply the brakes fully and put the engine into neutral. To stop the engine, switch off the ignition. Park the motorcycle on a firm surface and lock.

WARNING

- ALWAYS PARK YOUR MOTORBIKE ON A SOLID AND HORIZONTAL SURFACE.
- NEVER LEAVE YOUR MOTORCYCLE WITHOUT SUPERVISION AS LONG AS THE ENGINE IS RUNNING.
- MOTORCYCLE ENGINES PRODUCE A GREAT AMOUNT OF HEAT WHILE RUNNING. THE ENGINE RADIATORS, EXHAUST, EXHAUST SYSTEM, BRAKE DISCS, AND SHOCK ABSORBERS CAN BECOME VERY HOT. DO NOT TOUCH ANY OF THESE PARTS AFTER OPERATING THE MOTORCYCLE, AND TAKE CARE TO PARK IT WHERE PEDESTRIANS ARE NOT LIKELY TO TOUCH IT AND GET BURNED
- NEVER PARK YOUR MOTORCYCLE IN PLACES WHERE THERE EXIST FIRE HAZARDS DUE TO DRY GRASS OR OTHER EASILY FLAMMABLE MATERIALS.

CAUTION

ALWAYS TAKE OUT THE IGNITION KEY WHEN PARKING YOUR MOTORCYCLE SO THAT IT CANNOT BE USED BY UNAUTHORIZED PERSONS.



INFORMATION ABOUT THE SIDE STAND

Use your foot to push the side stand forward as far as possible, and lean your motorcycle to the side. Make sure that your motorcycle is standing safely on solid ground. Just in case, you can also put in a gear.

! CAUTION !

THE SIDE STAND IS DIMENSIONED FOR THE WEIGHT OF THE MOTORCYCLE ONLY. IF YOU ARE SITTING ON THE MOTORBIKE AND THUS APPLY AN ADDITIONAL LOAD ONTO THE SIDE STAND, YOU MAY CAUSE DAMAGE TO THE SIDE STAND OR THE FRAME, AND YOUR MOTORBIKE MAY FALL OVER.

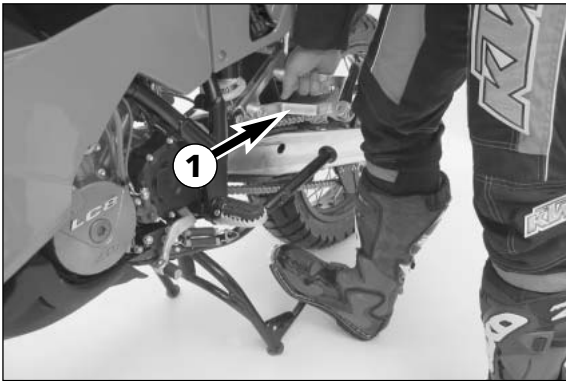

NOTE REGARDING THE CENTER STAND:

We advise the following procedure to place the motorcycle on the center stand as effortlessly as possible:

- a) press main stand to ground using foot
- b) put your weight on the stand stabilizer and pull the motorcycle back by the footrest support (see illustration).

Make sure that the ground is solid and that your motorcycle is standing securely.

! CAUTION !

- THE CENTER STAND IS DESIGNED TO HOLD THE WEIGHT OF THE MOTORCYCLE ONLY. BY SITTING ON THE MOTORCYCLE, YOU WILL PUT ADDITIONAL WEIGHT ON THE CENTER STAND, POSSIBLY CAUSING THE CENTER STAND OR FRAME TO BE DAMAGED OR THE MOTORCYCLE TO FALL DOWN.
- DO NOT PULL THE MOTORCYCLE BACK ON THE CENTER STAND BY HOLDING THE HAND WHEEL ② ON THE SHOCK ABSORBER ADJUSTMENT (IT COULD CAUSE THE SHOCK ABSORBER TO LEAK) BUT USE THE FOOTREST BRACKET ①.

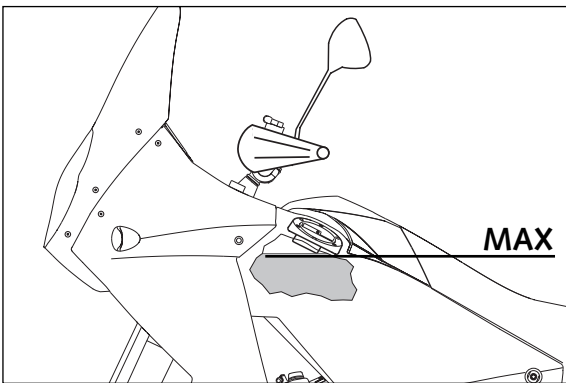
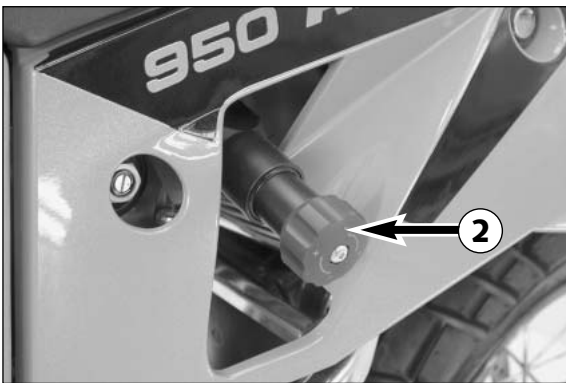

Fuel

In the condition at delivery, the LC8 engine requires unleaded premium-grade fuel with at least 95 octane (ROZ).

If using lower octane fuel, it is easy to change over to the pre-programmed ignition curve for 80 - 94 octane (ROZ) (see activating the ignition curve for low-octane fuel).

! CAUTION !

- USE UNLEADED PREMIUM-GRADE 95 OCTANE (ROZ) FUEL. IF USING LOWER OCTANE FUEL, THE IGNITION CURVE MUST BE CHANGED, OTHERWISE ENGINE DAMAGE WILL OCCUR.
- THIS MOTORCYCLE IS EQUIPPED WITH 2 CATALYTIC CONVERTERS. LEADED FUEL WILL DESTROY THE CATALYTIC CONVERTERS. PLEASE USE UNLEADED FUEL ONLY.

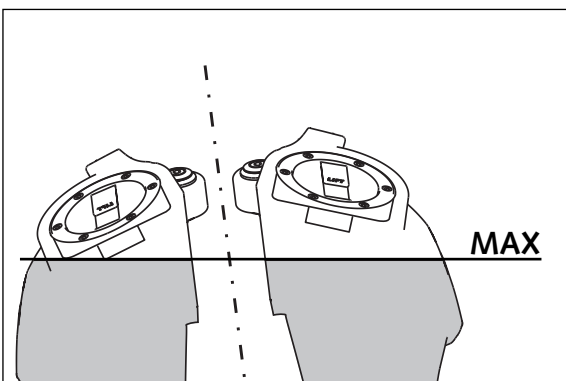

The 950 Adventure has 2 tanks with 1 filler neck each. Fill the right tank first, then the left tank (see drawing for the maximum filling level). If the right tank is filled up to the filler neck, fuel may overflow when the motorcycle is parked on the side stand after refueling when the fuel becomes warm.

⚠ WARNING ⚠

GASOLINE IS HIGHLY FLAMMABLE AND POISONOUS. EXTREME CAUTION SHOULD BE USED WHEN HANDLING GASOLINE. DO NOT REFUEL THE MOTORCYCLE NEAR OPEN FLAMES OR BURNING CIGARETTES. ALWAYS SWITCH OFF THE ENGINE BEFORE REFUELLING. BE CAREFUL NOT TO SPILL GASOLINE ON THE ENGINE OR EXHAUST PIPE WHILE THE ENGINE IS HOT. WIPE UP SPILLS PROMPTLY. IF GASOLINE IS SWALLOWED OR SPLASHED IN THE EYES, SEEK A DOCTOR'S ADVICE IMMEDIATELY.

A washed motorcycle can be checked more quickly which saves money!

1. Service after 1000 km	7500 km or once a year	15000 km or every 2 years
--------------------------	------------------------	---------------------------

	1. Service after 1000 km	7500 km or once a year	15000 km or every 2 years	
ENGINE	Change engine oil and oil filter	●	●	●
	Clean oil screens of engine and oil tank	●	●	●
	Clean magnetic drain plugs of engine and oil tank	●	●	●
	Check oil lines for damage and kink-less arrangement	●	●	●
	Renew spark plugs			●
	Check and adjust valve clearance	●		●
	Check engine fastening bolts for tight fit	●	●	●
	Check all engine bolts accessible from the outside for tight fit	●	●	●
	Check clutch linings			●
	Check clutch pressure booster system			●
CARBURETOR	Check carburetor connection boots for cracks and leaks	●		●
	Check synchronisation of carburetors using special tool, if necessary adjust	●		●
	Check idle setting (1400 rpm)	●		●
	Check breeder hoses and fuel lines for damage and kink-free arrangement	●		●
ADD-ON-PARTS	Check cooling system for leaks and antifreeze protection	●	●	●
	Check radiator fan for proper operation	●	●	●
	Check exhaust system for leaks and correct fitment	●	●	●
	Check actuating cables for damage, smooth operation, and kink-less arrangement, adjust and lubricate	●	●	●
	Check fluid level of the clutch master cylinder		●	●
	Check air filter, renew if necessary, clean air filter box			●
	Check cables for damage and kink-less arrangement	●	●	●
	Check headlamp adjustment	●	●	●
	Check electrical system for function (low/high beams, stop light, turn indicators, headlamp, flasher, tell-tale lamps, speedometer illumination, horn, side-stand switch, clutch switch, emergency-off switch)	●	●	●
	Make sure all bolts and nuts are tight	●	●	●
BRAKES	Check brake fluid level, lining thickness, and brake discs	●	●	●
	Change brake fluid			●
	Check brake lines for damage and leaks	●	●	●
	Check/adjust smooth operation, free travel of handbrake/footbrake levers	●	●	●
	Check bolts of brake system for tight fit	●	●	●
CHASSIS	Check suspension strut and fork for leaks and proper operation	●	●	●
	Clean fork dust sleeves		●	●
	Bleed fork legs	●	●	●
	Check swinging-fork pivot	●	●	●
	Check/adjust steering-head bearing	●	●	●
	Check all chassis bolts for tight fit (fork plates, fork leg, axle nuts/bolts, swinging-fork pivot, reversing lever, suspension strut)	●	●	●
WHEELS	Check spoke tension and rim joint	●	●	●
	Check tire condition and inflation pressure	●	●	●
	Check chain and chain guides for wear, force fit and tension	●	●	●
	Check bolts on pinion and chain sprocket for locking devices and a tight fit	●	●	●
	Lubricate chain	●	●	●
Check wheel bearings and jerk damper for play		●	●	

IF MOTORCYCLE IS USED FOR COMPETITION 7500 KM SERVICE SHOULD BE CARRIED OUT AFTER EVERY RACE! SERVICE INTERVALLS SHOULD NEVER BE EXCEEDED BY MORE THAN 500 KM. MAINTENANCE WORK DONE BY KTM AUTHORIZED WORKSHOPS IS NOT A SUBSTITUTE OF CARE AND CHECKS DONE BY THE RIDER!

IMPORTANT RECOMENDED MAINTENANCE PROCEDURES TO BE PERFORMED BASED ON A SEPARATE SUPPLEMENT ORDER		
	at least once a year	every 2 years or 15000 km
Perform complete fork maintenance		●
Perform complete suspension strut maintenance		●
Clean and lubricate steering-head bearing and sealing elements	●	
Clean and adjust the carburetors		●
Treat the electrical contacts and switches with contact spray	●	
Treat battery connections with contact grease	●	
Change coolant fluid		●

VITAL CHECKS AND CARE PROCEDURES TO CONDUCTED BY THE OWNER OR THE MECHANIC			
	before each start	after every cleaning	every 1000 km or after off road use
Check oil level	●		
Check brake fluid level	●		
Check brake pads for wear	●		
Check lighting system for proper operation	●		
Check horn for proper operation	●		
Lubricate and adjust actuating cables and nipples		●	
Bleed fork legs in regular intervals			●
Clean chain			●
Lubricate chain		●	●
Check chain tension	●		
Check tire pressure and wear	●		
Check coolant level	●		
Check fuel lines for leaks	●		
Check all control elements for smooth running	●		
Check brake performance	●	●	
Treat exposed metal components (except for the braking and exhaust systems) with wax-based anti-corrosion agents		●	
Treat ignition/steering lock and light switch with contact spray		●	

MAINTENANCE WORK ON CHASSIS AND ENGINE



WARNING



ALL SERVICING AND ADJUSTMENT PROCEDURES DESIGNATED BY AN ASTERISK * REQUIRE THE KNOWLEDGE AND SKILLS OF A PROFESSIONAL. IN THE INTEREST OF YOUR OWN SAFETY, HAVE THESE PROCEDURES CARRIED OUT AT A AUTHORIZED KTM WORKSHOP! AT A KTM WORKSHOP YOUR MOTORCYCLE WILL RECEIVE OPTIMAL SERVICING BY SPECIALLY TRAINED MECHANICS.



CAUTION



- WHEN CLEANING THE MOTORCYCLE, DO NOT USE A HIGH PRESSURE CLEANING UNIT IF POSSIBLE, OTHERWISE WATER WILL PENETRATE THE BEARINGS, CARBURETOR, ELECTRIC CONNECTORS ETC.
- DO NOT USE TOOTHED WASHERS OR SPRING WASHERS WITH THE ENGINE FASTENING SCREWS, AS THESE WORK INTO THE FRAME PARTS AND KEEP WORKING LOOSE. INSTEAD, USE SELF-LOCKING NUTS.
- LET YOUR MOTORCYCLE COOL DOWN BEFORE BEGINNING ANY MAINTENANCE WORK IN ORDER TO AVOID GETTING BURNED.
- DISPOSE OF OIL, GREASE, FILTERS, FUELS, CLEANING AGENTS ETC. ACCORDING TO YOUR LOCAL REGULATIONS.
- UNDER NO CIRCUMSTANCES MAY USED OIL BE DISPOSED OF IN THE SEWAGE SYSTEM OR IN THE OPEN COUNTRYSIDE. 1 LITER USED OIL CONTAMINATES 1,000.000 LITERS WATER.
- IF YOU UNFASTEN SELF-LOCKING NUTS, YOU HAVE TO REPLACE THEM BY NEW ONES.
- IF YOU UNFASTEN SCREWS AND NUTS SECURED BY LOCTITE, YOU HAVE TO REATTACH AND SECURE THEM IN THE SAME WAY. SEE TECHNICAL SPECIFICATIONS - FASTENING TORQUES.



Removing and remounting the seat

Insert the ignition key in the seat lock and turn in a counterclockwise direction to unlock the seat. Lift the back of the seat and pull off towards the rear.

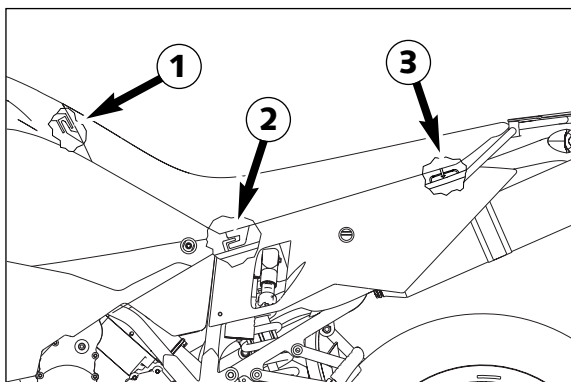

To remount, fit the nose ① of the seat in the front, lower the back while pushing towards the front. Both noses ② should fit into the frame. Insert the catch bolts ③ in the lock housing and push the seat down in the back until you hear the catch bolts snap into place. Check whether the seat is correctly mounted.



CAUTION



IF NOT CORRECTLY MOUNTED, THE SEAT CAN SLIP WHILE YOU ARE DRIVING AND CAUSE YOU TO LOSE CONTROL OF YOUR MOTORCYCLE.

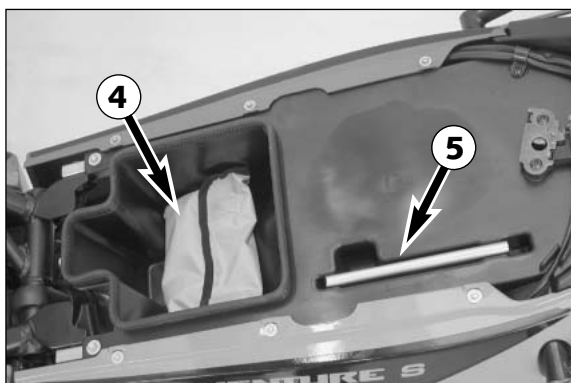

Tool set

The tool set ④ and a recess ⑤ for several tool set wrenches are found under the seat.

BASIC SETTING FORK 950 Adventure 950 Adventure S	Driving Comfort	Basic Setting	Driving Sport	Maximum Payload
Compression adjuster (clicks)	20	15	15	15
Rebound adjuster (clicks)	18	18	15	18
Spring preload (turns)	5	5	8	5

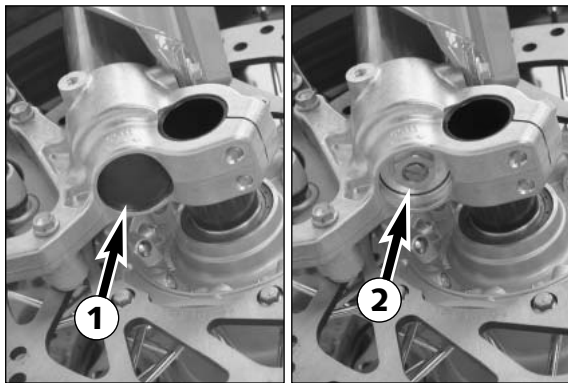

Adjusting the fork and shock absorber

There are a number of ways to adjust the fork and shock absorber to match the chassis to your driving style and the payload.

We have provided a table with pragmatical values to help you tune up your motorcycle. These tune-up specifications are reference values only and should serve as a basis for your personal chassis and suspension tuning. Do not make arbitrary changes to the settings (maximum $\pm 40\%$) since this may impair the handling characteristics (particularly in the high-speed range).

We recommend the "Driving Sport" damping adjustment for off-road rides on soft subgrades (e.g. sand) and the "Driving Comfort" damping adjustment for off-road rides on hard subgrades (e.g. rocks).

Adjusting compression damping of fork

Hydraulic compression damping determines the reaction when the fork is compressed. The degree of compression can be adjusted with adjusting screws at the bottom of the fork legs. Remove the protecting cap 1.

Turn the adjusting screws 2 clockwise to increase damping, turn it counterclockwise to reduce damping during compression. Make the same damping rate adjustments to both fork legs.

STANDARD ADJUSTMENT

- turn adjusting screw clockwise as far as it will go
- Turn 15 clicks in a counterclockwise direction.

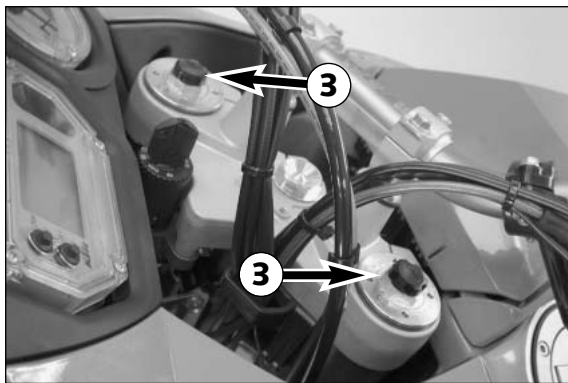

Adjusting rebound damping of fork

Hydraulic rebound damping determines the reaction when the fork is rebound. By turning the adjusting screw 3 (REB), the degree of damping of the rebound can be adjusted. Turn the knob clockwise to increase damping, turn it counterclockwise to reduce damping during rebounding. Make the same damping rate adjustment to both fork legs.

STANDARD ADJUSTMENT

- turn adjusting screw clockwise as far as it will go
- Turn 18 clicks in a counterclockwise direction.

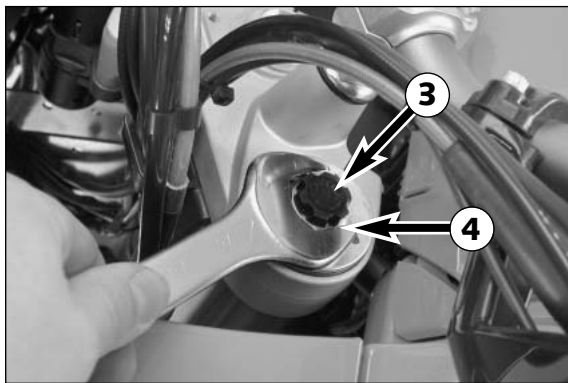

Adjusting the spring preload on the fork

The fork spring preload can be adjusted by turning the adjusting screws 4 (wrench size 24 mm) ± 5 mm (0,2 in).

Turning in a clockwise direction will increase the preload, turning in a counterclockwise direction will decrease the preload. 1 turn will change the preload by 1 mm.

Changing the preload will not affect the rebound damping adjustment, although adjusting screw 3 will turn at the same time.

Generally, if the preload is higher, the rebound damping should also be set higher.

STANDARD ADJUSTMENT:

Turn the adjusting screw in a counterclockwise direction up to the stop and then 5 turns in a clockwise direction.

BASIC SETTING SHOCK ABSORBER 950 Adventure	Driving Comfort	Basic setting	Driving Sport	Maximum Payload
Compression adjuster Low Speed (clicks)	12	8	6	6
Compression adjuster High Speed (turns)	1,5	1,5	1	1
Rebound adjuster (clicks)	17	12	10	10
Spring preload (turns)	6	6	8	18

BASIC SETTING SHOCK ABSORBER 950 Adventure S	Driving Comfort	Basic setting	Driving Sport	Maximum Payload
Compression adjuster Low Speed (clicks)	15	12	8	8
Compression adjuster High Speed (turns)	1,5	1,5	1	1
Rebound adjuster (clicks)	20	17	13	13
Spring preload (turns)	6	6	12	12



Compression damping of shock absorber

The shock absorber can synchronize the compression damping in the low and high-speed range separately (Dual Compression Control). Low and high speed refers to the movement of the shock absorber during compression and not to the speed of the motorcycle. The low and high-speed technology overlaps. The low-speed setting is primarily for slow to normal shock absorber compression rates. The high-speed setting is effective at fast compression rates. Turning in a clockwise direction will increase the damping, turning counterclockwise will decrease the damping.



STANDARD ADJUSTMENT LOW-SPEED:

- turn the adjusting screw ① to the limit in a clockwise direction using a screwdriver.
- unscrew the respective number of clicks for the specific type of shock absorber in a counterclockwise direction.



STANDARD ADJUSTMENT HIGH-SPEED:

- Turn the adjusting screw in a clockwise direction up to the stop with a socket wrench (wrench size 17 mm).
 - Turn the adjusting screw in a counterclockwise direction the number of turns specified for the respective type of shock absorber.
- 950 Adventure8 clicks
950 Adventure S12 clicks

⚠ **WARNING** ⚠

THE DAMPING UNIT OF THE SHOCK ABSORBER IS FILLED WITH HIGH-COMPRESSION NITROGEN. NEVER TRY TO TAKE THE SHOCK ABSORBER APART OR TO DO ANY MAINTENANCE WORK YOURSELF. SEVERE INJURIES COULD BE THE RESULT. NEVER UNSCREW THE BLACK SCREW CONNECTION (24MM).

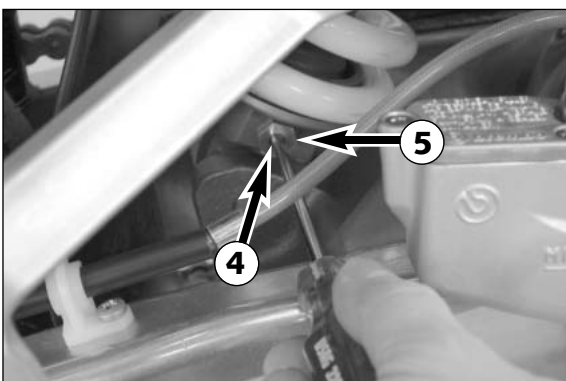

Rebound damping of shock absorber

By using the adjusting screw ④, the degree of damping of the rebound can be adjusted. Turn the knob in a clockwise direction to increase damping, turn it in a counterclockwise direction to reduce damping during rebounding.

STANDARD ADJUSTMENT:

- turn the adjusting screw clockwise to the stop.
 - then turn the adjusting screw counterclockwise, counting the number of clicks that corresponds to the respective type of shock absorber.
- 950 Adventure12 clicks
950 Adventure S17 clicks

⚠ **WARNING** ⚠

THE DAMPING UNIT OF THE SHOCK ABSORBER IS FILLED WITH HIGH-COMPRESSION NITROGEN. NEVER TRY TO TAKE THE SHOCK ABSORBER APART OR TO DO ANY MAINTENANCE WORK YOURSELF. SEVERE INJURIES COULD BE THE RESULT. NEVER UNSCREW THE BLACK SCREW CONNECTION ⑤ (15MM).

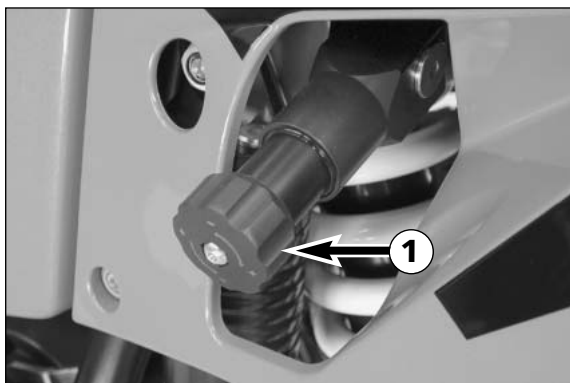

Adjusting the preload of the shock absorber

The baggage and passenger put the main load on the shock absorber. To guarantee maximum handling performance, the preload of the shock absorber must be adapted to the load.

The preload is hydraulically adjusted by turning the hand wheel ❶. Turning in a clockwise direction will increase the preload, turning in a counterclockwise direction will reduce the preload.

Our pragmatcal values are provided in the table "Basic settings for the shock absorber" to help you to make the necessary adjustments.

STANDARD ADJUSTMENT:

- Turn the hand wheel in a counterclockwise direction up to the stop
- Turn the hand wheel 6 turns in a clockwise direction

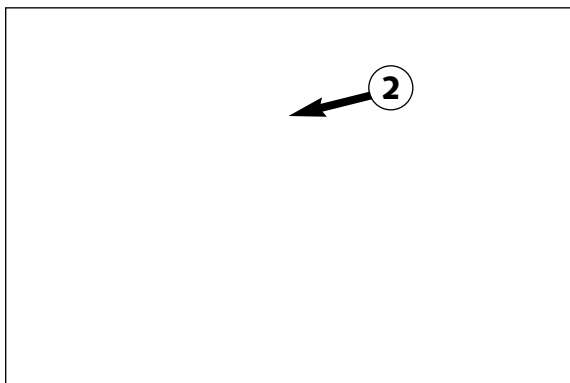

Breathing the fork legs

Breath the fork legs regularly (see Maintenance Schedule).

To breath, place the motorcycle on the side stand and briefly remove the bleeder screws ❷ to allow any overpressure to escape from the fork.

! CAUTION !

EXCESSIVE PRESSURE IN THE INTERIOR OF THE FORK CAN CAUSE LEAKS IN THE FORK. IF YOUR FORK IS LEAKING, IT IS RECOMMENDED TO OPEN THE BREATHER PLUGS BEFORE HAVING THE SEALS REPLACED.

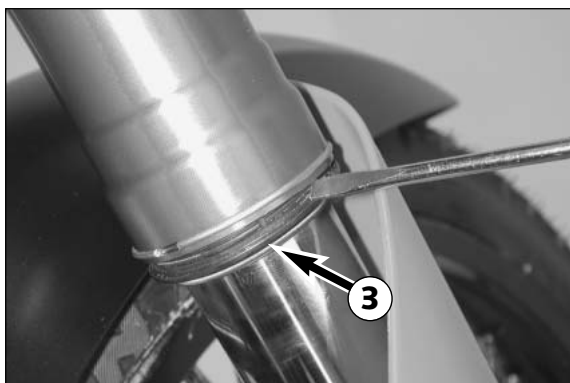

Cleaning the dust sleeves of the telescopic fork

The dust-protection bellows ❸ are to remove dust and coarse dirt particles from the fork tube. However, after some time, dirt may also get in behind the dust-protection bellows. If this dirt is not removed, the oil sealing rings located behind it may start to leak.

Use a screwdriver to lever the dust-protection bellows out of the outer tubes and slide them downward.

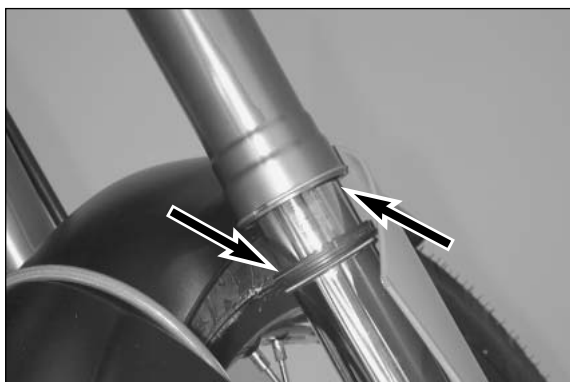

Clean dust-protection bellows, outer tubes, and fork tubes thoroughly, and oil them thoroughly with silicone spray. Then, push dust-protection bellows into the outer tubes by hand.

! CAUTION !

NO SILICONE OIL MAY REACH THE FRONT TIRE OR THE BRAKE DISKS SINCE THIS WOULD CONSIDERABLY REDUCE THE TIRE'S ROAD GRIP AND THE BRAKING EFFECT OF THE FRONT BRAKE.

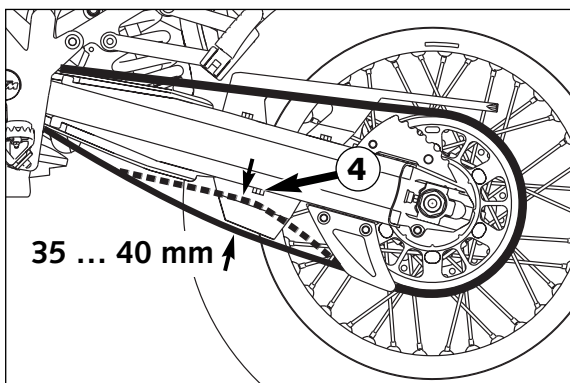

Checking the chain tension

Place the motorcycle on the side stand and switch the transmission to idle. The chain should sag 35...40 mm (1.37 ... 1.57 in) at the lower chainguard screw ❹.

⚠ WARNING ⚠

- IF CHAIN TENSION IS TOO GREAT, PARTS WITHIN THE SECONDARY POWER TRANSMISSION (CHAIN, CHAIN SPROCKETS, TRANSMISSION AND REAR WHEEL BEARINGS) WILL BE SUBJECTED TO UNNECESSARY STRESS, RESULTING IN PREMATURE WEAR AND EVEN CHAIN BREAKAGE.
- TOO MUCH SLACK IN THE CHAIN, ON THE OTHER HAND, CAN RESULT IN THE CHAIN JUMPING OFF THE CHAIN WHEELS. IF THIS HAPPENS, THE CHAIN COULD ALSO BLOCK THE REAR WHEEL OR DAMAGE THE ENGINE.
- IN EITHER CASE THE OPERATOR IS LIKELY TO LOSE CONTROL OF THE MOTORCYCLE.

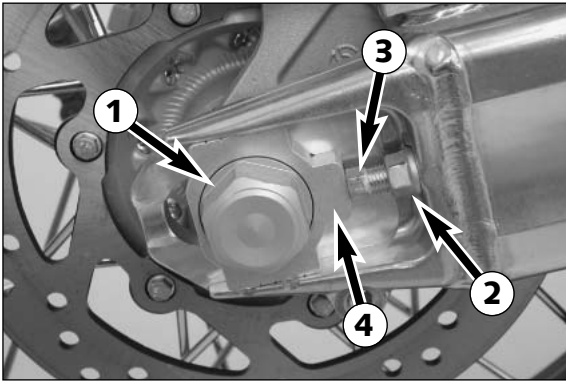

Correct chain tension

Loosen collar nut ①, loosen counter nuts ②, and turn right and left adjusting screws ③ equally far. Tighten counter nuts ②. Before tightening the wheel spindle, verify that the chain adjusters ④ are sitting close to the adjusting screws and that the rear wheel has been aligned with the front wheel. Tighten collar nut ① with 110 Nm.

⚠ **WARNING** ⚠

IF YOU DON'T HAPPEN TO HAVE A TORQUE WRENCH AT HAND, MAKE SURE YOU HAVE THE TIGHTENING TORQUE CORRECTED BY A KTM DEALER AS SOON AS POSSIBLE. A LOOSE AXLE MAY LEAD TO AN UNSTABLE DRIVING BEHAVIOR OF YOUR MOTORCYCLE.

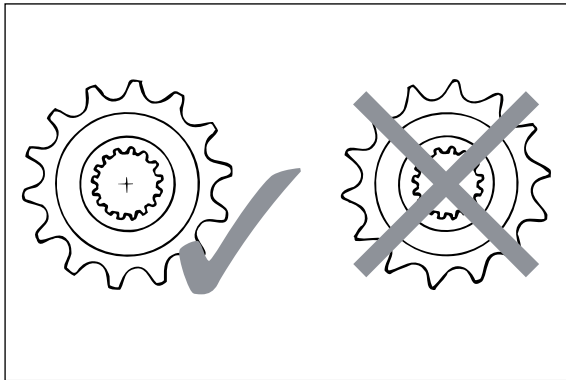
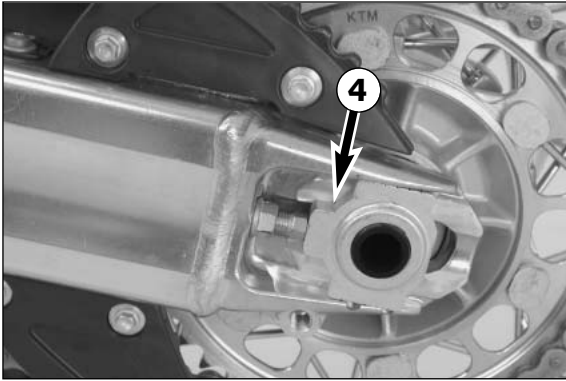

Chain maintenance

The maintenance of the X-ring chain is reduced to a minimum. Clean with a soft water jet. Never use a brush or solvent to clean the chain. When the chain is dry use a chain spray specially made for X-ring chains (Motorex Chainlube 622).

⚠ **WARNING** ⚠

- NO LUBRICATION IS ALLOWED TO REACH THE REAR TIRE OR THE BRAKE DISK, EITHERWISE THE ROAD ADHERENCE AND THE REAR WHEEL BRAKING EFFECTS WOULD BE STRONGLY REDUCED AND THE MOTORCYCLE COULD EASILY GET OUT OF CONTROL.
- THE CHAIN DOES NOT HAVE A CHAIN JOINT FOR SAFETY REASONS. ALWAYS HAVE THE CHAIN REPLACED IN AN AUTHORIZED KTM WORKSHOP WHERE THE SERVICE TECHNICIANS HAVE THE REQUIRED RIVETING TOOL.
- NEVER MOUNT A NORMAL CHAIN JOINT.

Also check sprockets and chain guides for wear, and replace if necessary.

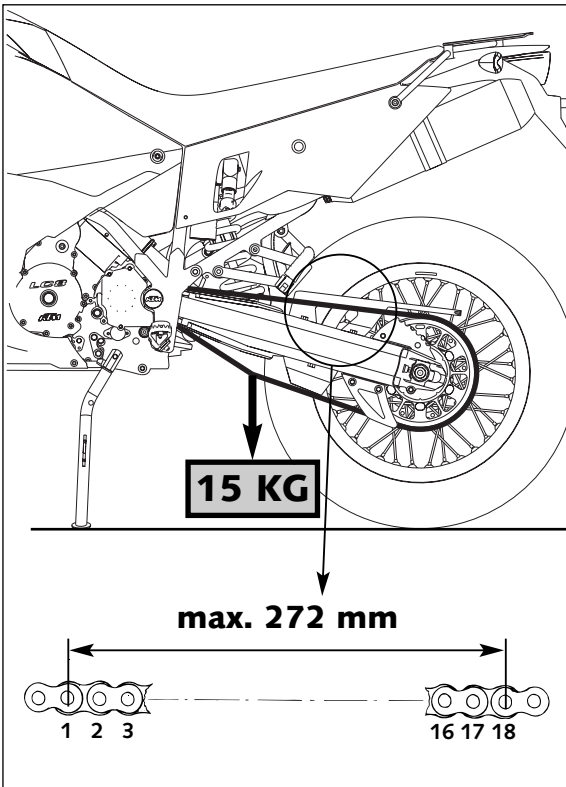

Checking the chain for wear

To check the chain for wear proceed as follows: Switch the transmission to idle and put a load of approx. 15 kilograms (33 lbs) on the lower part of the chain (see illustration). Now measure the distance between 18 chain rollers on the upper part of the chain. The chain needs to be replaced when the distance is 272 mm (10.70 in). Since chains do not always wear evenly, repeat the measurement at different parts of the chain. Replace the chain if any X-rings are missing.

NOTE:

If you mount a new chain, the sprockets should also be replaced. New chains wear faster if used on old used sprockets.

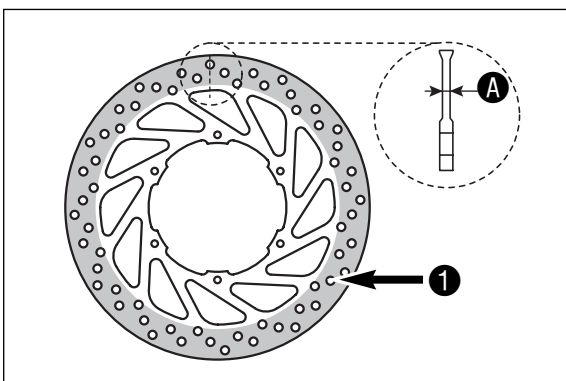
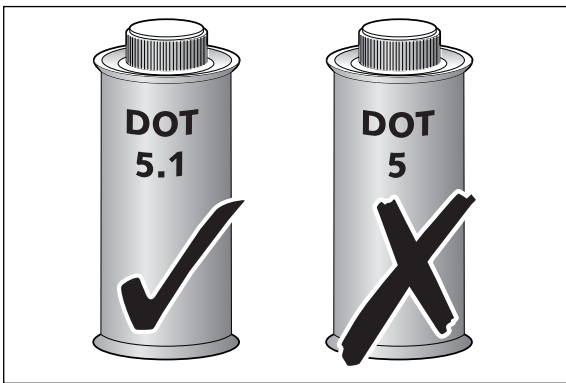
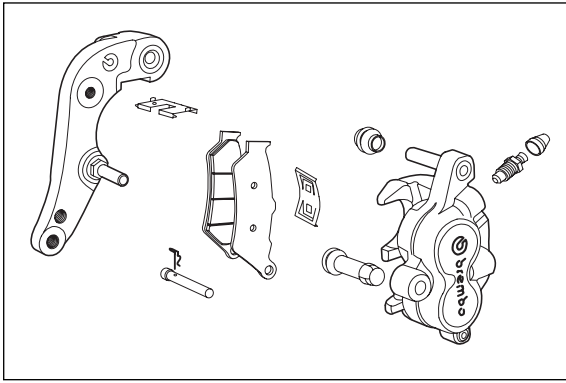

General informations about KTM disc brakes

BRAKE CALIPERS:

The brake calipers of this series "float". This means that the brake calipers are not solidly attached to the caliper support. Thus, the brake pads are always in optimum contact with the brake disc. Secure the screws of the caliper support with Loctite 243 and tighten to 25 Nm.



WARNING



FOR SAFETY REASONS, ALWAYS HAVE MAINTENANCE WORK AND REPAIRS TO THE BRAKE SYSTEM PERFORMED BY AN AUTHORIZED KTM WORKSHOP.

BRAKE PADS:

Your motorcycle is equipped with sintered brake pads in the front and rear and homologated accordingly. They guarantee maximum braking performance.

Front brake pads: Toshiba TT 2172 HH
Rear brake pads: Toshiba TT 2701 HH



WARNING



BRAKE PADS AVAILABLE IN THE ACCESSORY TRADE ARE OFTEN NOT AUTHORIZED FOR OPERATION OF YOUR KTM MOTORCYCLE IN ROAD TRAFFIC. THE BRAKE PADS DESIGN AND FRICTION FACTOR AND THEREFORE THE BRAKING POWER CAN DEVIATE SIGNIFICANTLY FROM ORIGINAL KTM BRAKE PADS. IF YOU USE DIFFERENT BRAKE PADS THAN THOSE PROVIDED WITH THE ORIGINAL EQUIPMENT, IT CANNOT BE WARRANTED THAT THEY ARE AUTHORIZED FOR USE IN ROAD TRAFFIC. YOUR MOTORCYCLE WILL NOT LONGER COMPLY WITH THE REGULATIONS AUTHORIZING THE USE OF VEHICLES FOR ROAD TRAFFIC AND THE WARRANTY WILL BE VOID.

BRAKE FLUID RESERVOIRS:

The brake fluid reservoirs on the front and rear wheel brakes have been designed in such a way that even if the brake pads are worn it is not necessary to top up the brake fluid. There is no reason to remove the reservoir cap under normal conditions. If the brake fluid level drops below the minimum either the brake system has a leak or the brake pads are completely worn down. In this case, consult an authorized KTM dealer immediately.

BRAKE FLUID:

KTM fills the brake systems with Motorex Brake Fluid DOT 5.1 brake fluid, one of the best brake fluids that is currently available. We recommend that you continue to use it. DOT 5.1 brake fluid is based on glycol ether and of an amber color. If you do not have any DOT 5.1 for refilling, you may use DOT 4 brake fluid. However, you should replace it as soon as possible by DOT 5.1.

Never use DOT 5 braking fluid. It is based on silicone oil and has a purple color. Gaskets and brake hoses are not compatible with it.

Brake fluid is exposed to a high thermal load and absorbs moisture from the air, which lowers the boiling point. The brake fluid should therefore be changed at the prescribed intervals.



WARNING



HAVE THE BRAKE FLUID FOR THE FRONT AND REAR BRAKE CHANGED AT AN AUTHORIZED KTM WORKSHOP EVERY 2 YEARS.

BRAKE DISCS:

Wear reduces the thickness of the brake disc in the area of contact ❶ with the brake pads. The brake disk should not be thinner than 4.5 mm (0.18 in) at the weakest point ❷. Check the wear at several points.



WARNING



BRAKE DISKS THAT ARE LESS THAN 4.5 MM (0.18 IN) THICK ARE A SAFETY HAZARD. HAVE WORN BRAKE DISKS REPLACED IMMEDIATELY.

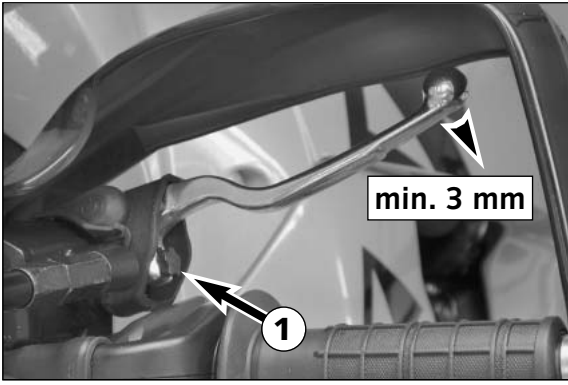

Adjusting of free travel at the hand brake lever

Free travel at the hand brake lever may be readjusted by using adjusting screw ①. In this way, the position of the point of pressure (i.e., the resistance you feel on the hand brake lever when the brake pads are pressed against the brake disc) can be adjusted for any hand size.

! CAUTION !

AT THE HAND BRAKE LEVER, FREE TRAVEL MUST AT LEAST BE 3 MM (0.12 IN). ONLY THEN MAY THE PISTON IN THE HAND BRAKE CYLINDER BE MOVED (TO BE RECOGNIZED BY THE GREATER RESISTANCE OF THE HAND BRAKE LEVER). IF THIS FREE TRAVEL IS NOT PROVIDED, PRESSURE WILL BUILD UP IN THE BRAKING SYSTEM, AND THE FRONT WHEEL BRAKE MAY FAIL DUE TO OVERHEATING.

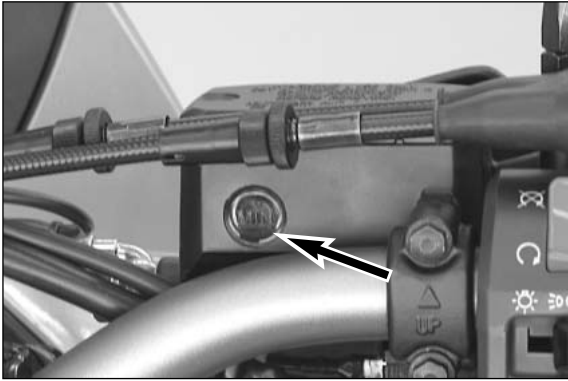

Checking of brake fluid level - front brake

The brake fluid reservoir is linked with the hand brake cylinder at the handlebar and the reservoir is provided with an inspection glass. With the reservoir in a horizontal position, the brake fluid level should not go below middle of the glass.

⚠ WARNING ⚠

- IF THE BRAKE FLUID LEVEL DROPS BELOW THE MINIMUM EITHER THE BRAKE SYSTEM HAS A LEAK OR THE BRAKE PADS ARE COMPLETELY WORN DOWN. IN THIS CASE, CONSULT AN AUTHORIZED KTM DEALER IMMEDIATELY.
- HAVE THE BRAKE FLUID CHANGED AT AN AUTHORIZED KTM WORKSHOP EVERY 2 YEARS.

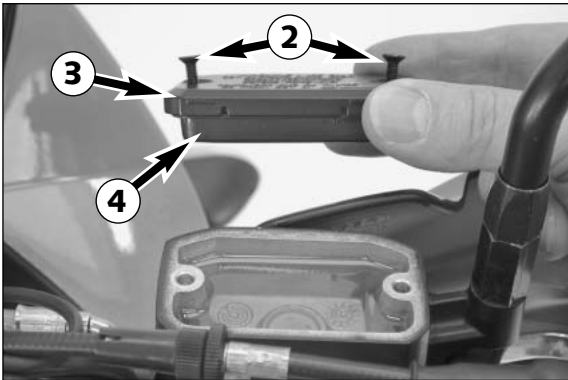

Refilling the front brake fluid reservoir *

It is not necessary to refill brake fluid under normal conditions (see General information on KTM disk brakes).

However, the brake fluid must be refilled as soon as the brake fluid level reaches the MIN mark.

Remove the screws ② and the cover ③ with the rubber boot ④. Push the front brake caliper pistons all the way back, demounting the front wheel if necessary. Move the hand brake cylinder in a horizontal position and fill DOT 5.1 brake fluid (Motorex Brake Fluid DOT 5.1) up to 5 mm (0.2 in) under the top edge of the reservoir. Remount the rubber boot, cover and screws. Wash off any overflowing or spilled brake fluid with water. Actuate the front brake until you feel the point of pressure.

⚠ WARNING ⚠

- ACTUATE THE FRONT BRAKE UNTIL YOU FEEL THE POINT OF PRESSURE.
- NEVER USE DOT5 BRAKE FLUID! IT IS BASED ON SILICONE OIL AND OF A PURPLE COLOR. SEALS AND BRAKE HOSES MUST BE ESPECIALLY ADAPTED TO IT.
- STORE BRAKE FLUID OUT OF REACH OF CHILDREN.
- BRAKE FLUID CAN CAUSE SKIN IRRITATION. AVOID CONTACT WITH SKIN AND EYES. IF YOU GET BRAKE FLUID IN YOUR EYES, RINSE WITH PLENTY OF WATER AND CONSULT A DOCTOR.

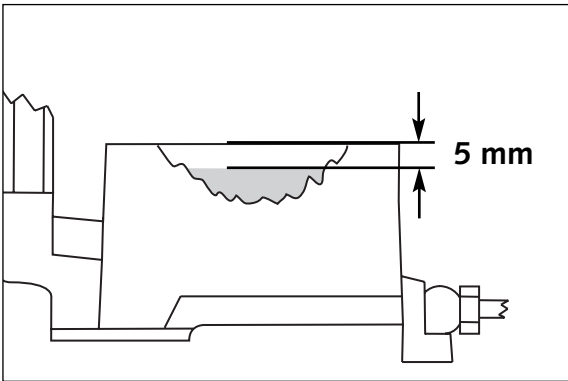

! CAUTION !

- DON'T LET BRAKE FLUID GET IN CONTACT WITH PAINT, IT IS AN EFFECTIVE PAINT REMOVER.
- USE ONLY CLEAN BRAKE FLUID TAKEN FROM A TIGHTLY SEALED CONTAINER.

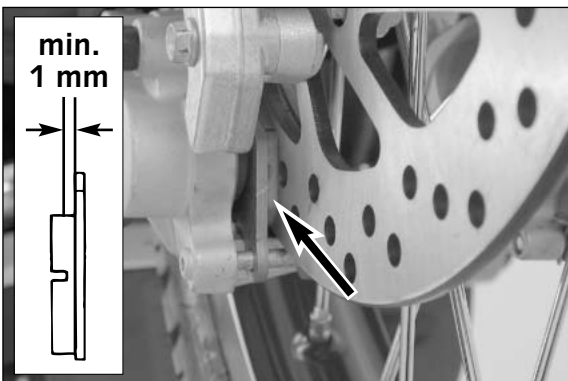

Checking the front brake pads

The brake pads can be inspected from below. The linings must be at least 1 mm (0.04 in) thick.

⚠ WARNING ⚠

AT THEIR MOST WORN POINT BRAKE PAD LININGS SHOULD NOT BE THINNER THAN 1 MM, OTHERWISE THEY COULD LEAD TO BRAKE FAILURE. FOR YOUR OWN SAFETY DON'T PUT OFF HAVING YOUR BRAKE PADS CHANGED.

! CAUTION !

IF THE BRAKE PADS ARE REPLACED TOO LATE WHEN THE LINING IS PARTLY OR COMPLETELY WORN OFF, THE STEEL PARTS ON THE BRAKE PADS WILL GRIND AGAINST THE BRAKE DISKS. THIS SIGNIFICANTLY DECREASES THE BRAKING EFFECT AND DESTROYS THE BRAKE DISKS.

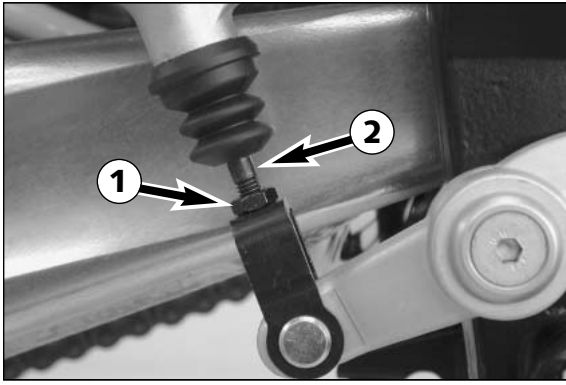

Changing the basic position of the foot brake lever *

Loosen the counter nut ❶ and turn the push rod ❷ until the foot brake lever reaches the right position. Tighten the counter nut.

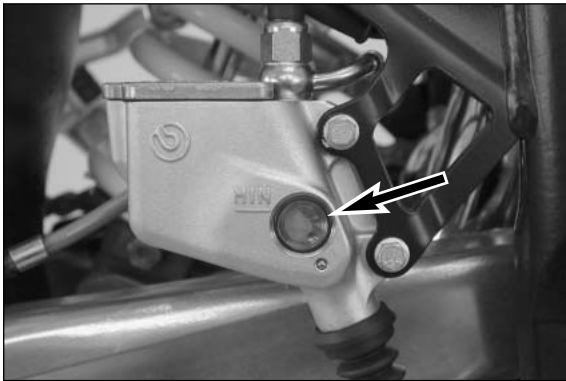

Checking rear brake fluid level

The brake fluid reservoir for the rear disk brake is combined with the foot brake cylinder and has an inspection window. The brake fluid level should not drop below the "MIN" mark when the motorcycle is in a vertical position.



WARNING



- IF THE BRAKE FLUID LEVEL DROPS BELOW THE MINIMUM EITHER THE BRAKE SYSTEM HAS A LEAK OR THE BRAKE PADS ARE COMPLETELY WORN DOWN. IN THIS CASE, CONSULT AN AUTHORIZED KTM DEALER IMMEDIATELY.
- HAVE THE BRAKE FLUID CHANGED AT AN AUTHORIZED KTM WORKSHOP EVERY 2 YEARS.

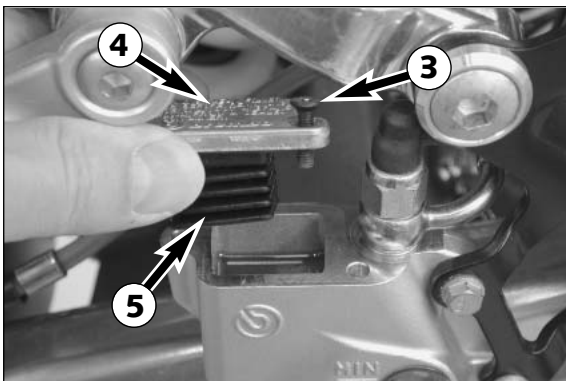

Refilling the rear brake fluid reservoir *

It is not necessary to refill brake fluid under normal conditions (see General information on KTM disk brakes).

However, the brake fluid must be refilled as soon as the brake fluid level reaches the MIN mark.

Remove the screws ❸ and the cover ❹ with the rubber boot ❺. Push the rear brake caliper pistons all the way back, demounting the rear wheel if necessary. Fill DOT 5.1 brake fluid (Motorex Brake Fluid DOT 5.1) up to 12 mm (0.5 in) under the top edge of the reservoir. Remount the rubber boot, cover and screws. Wash off any overflowing or spilled brake fluid with water. Actuate the rear brake until you feel the point of pressure.



WARNING



- ACTUATE THE REAR BRAKE UNTIL YOU FEEL THE POINT OF PRESSURE.
- NEVER USE DOT5 BRAKE FLUID! IT IS BASED ON SILICONE OIL AND OF A PURPLE COLOR. SEALS AND BRAKE HOSES MUST BE ESPECIALLY ADAPTED TO IT.
- STORE BRAKE FLUID OUT OF REACH OF CHILDREN.
- BRAKE FLUID CAN CAUSE SKIN IRRITATION. AVOID CONTACT WITH SKIN AND EYES. IF YOU GET BRAKE FLUID IN YOUR EYES, RINSE WITH PLENTY OF WATER AND CONSULT A DOCTOR



CAUTION



- DON'T LET BRAKE FLUID GET IN CONTACT WITH PAINT, IT IS AN EFFECTIVE PAINT REMOVER.
- USE ONLY CLEAN BRAKE FLUID TAKEN FROM A TIGHTLY SEALED CONTAINER.

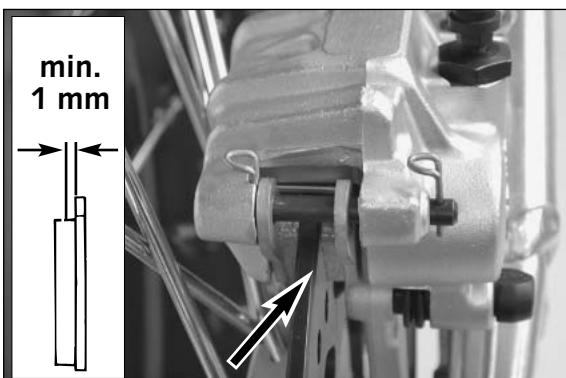
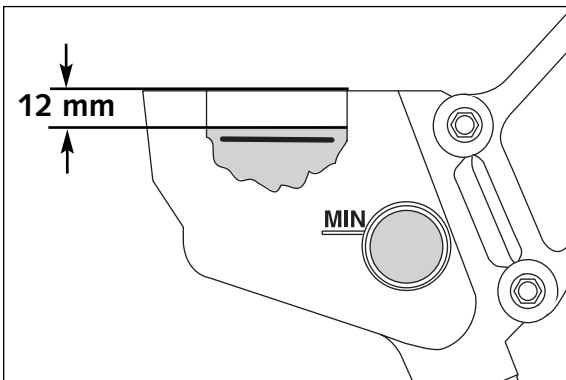

Checking the rear brake pads

The brake pads can be inspected from the rear. The thickness of the linings may not be less than 1 mm (0.04 in).



WARNING



AT THEIR MOST WORN POINT BRAKE PAD LININGS SHOULD NOT BE THINNER THAN 1 MM, OTHERWISE THEY COULD LEAD TO BRAKE FAILURE. FOR YOUR OWN SAFETY DON'T PUT OFF HAVING YOUR BRAKE PADS CHANGED.



CAUTION



IF THE BRAKE PADS ARE REPLACED TOO LATE SO THAT THE LINING IS PARTLY OR ENTIRELY WORN AWAY, THE STEEL COMPONENTS OF THE BRAKE PAD WILL RUB AGAINST THE BRAKE DISC, IMPAIRING THE BRAKING EFFECT AND DESTROYING THE BRAKE DISC.

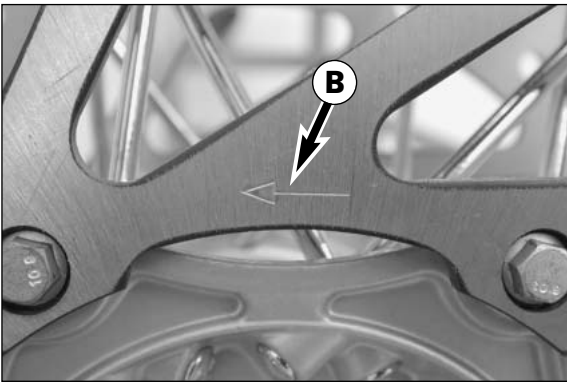
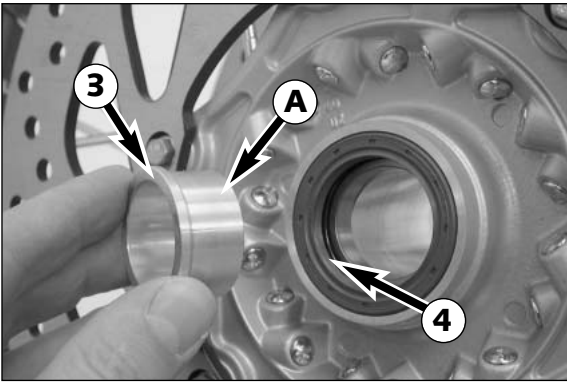
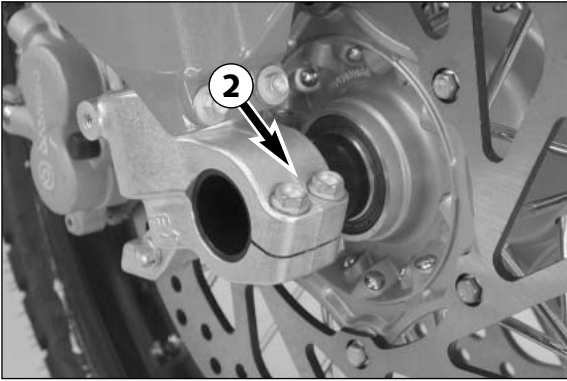
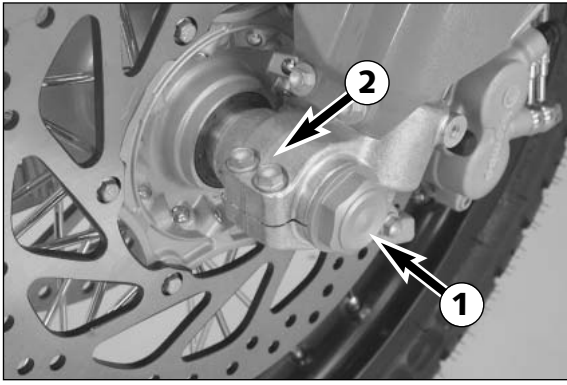

Dismounting and mounting the front wheel *

Jack the motorcycle up at the underride protection until the front wheel no longer touches the ground.

Loosen the collar screw ❶ and the clamp screws ❷ at both fork leg axle passages. Unscrew the collar screw approx. 8 turns, pressing your hand against the collar screw to push the axle passage out of the fork leg and remove the collar screw. Hold the front wheel and pull out the axle passage. Slightly pull one brake caliper out and take the front wheel off the fork.

Take the left ❸ and right distance bushing out of the shaft seal rings.

! CAUTION !

- DO NOT OPERATE THE HAND BRAKE WHEN THE FRONT WHEEL HAS BEEN DISMOUNTED.
- BE CAREFUL NOT TO DAMAGE THE BRAKE DISKS WHEN YOU LAY THE FRONT WHEEL DOWN.

Before remounting the front wheel, clean and grease the shaft seal rings ❹ and the bearing surface A of the distance bushings and mount the distance bushings (wide distance bushing in the left shaft seal ring). Slightly push back the brake pads with a screwdriver. Position the front wheel against the brake disks according to the direction of travel (see arrow B).

To mount the front wheel, lift the wheel into the fork, slightly pull one brake caliper out and push the tire in between the brake calipers. Insert the brake disks in the brake calipers and mount the axle passage.

Mount the collar screw ❶ and tighten slightly. Tighten the clamp screws ❷ on the right fork leg axle passage (in the direction of travel) tighten to prevent the axle passage from turning and tighten the collar nut to 60 Nm.

Loosen the clamp screws on the right fork leg axle passage, take the motorcycle off the stand, actuate the front wheel brake and vigorously compress the fork several times to align the fork legs.

Now you can tighten the clamp screws on both fork leg axle passages to 10 Nm.

⚠ WARNING ⚠

- IF YOU DO NOT HAVE A TORQUE WRENCH TO MOUNT THE WHEEL, HAVE THE TORQUES CORRECTED BY AN AUTHORIZED KTM WORKSHOP AS SOON AS POSSIBLE. A LOOSE AXLE PASSAGE CAN CAUSE THE MOTORCYCLE'S HANDLING PERFORMANCE TO BECOME INSTABLE.
- AFTER MOUNTING THE FRONT WHEEL, KEEP OPERATING THE HAND BRAKE UNTIL THE PRESSURE POINT RETURNS.
- ALWAYS KEEP THE BRAKE DISKS FREE FROM OIL AND GREASE, OTHERWISE THE BRAKING EFFECT WILL BE SIGNIFICANTLY REDUCED.

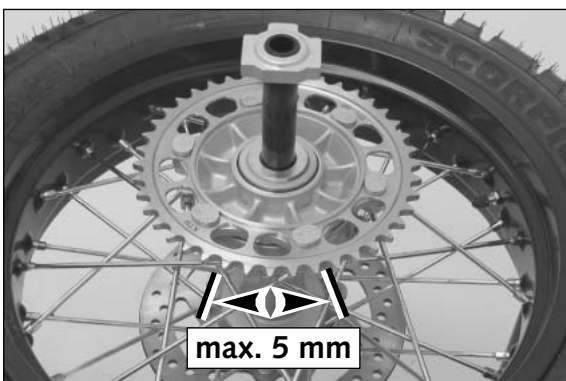
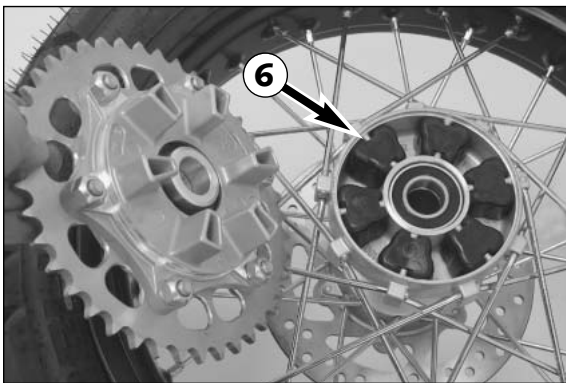
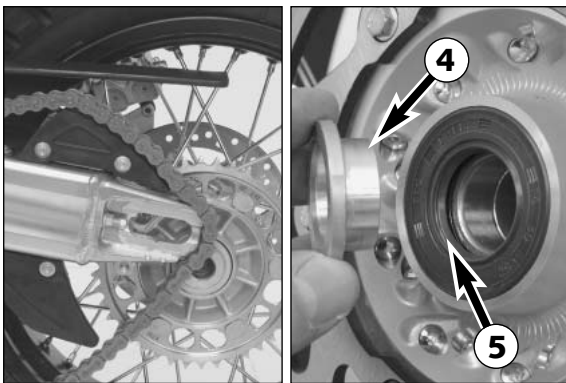
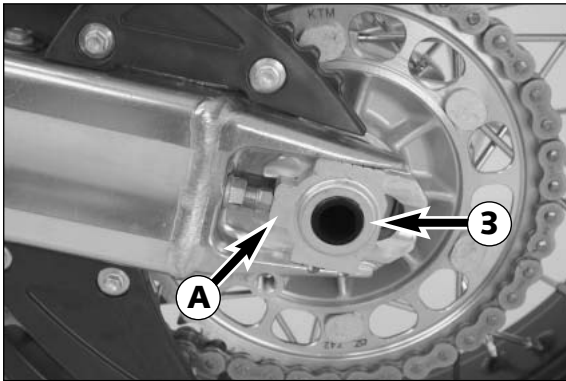
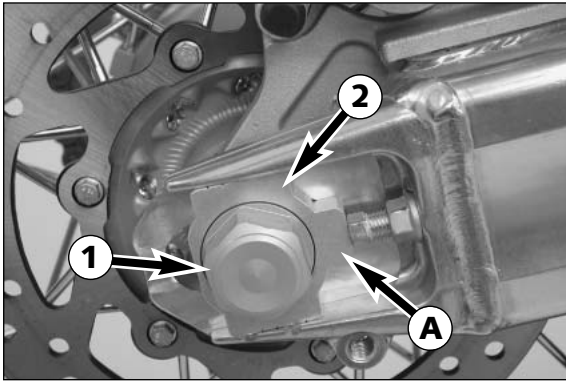

Dismounting and mounting the rear wheel *

Set the motorcycle on the center stand to keep the rear wheel from touching the ground.

Unscrew the collar nut ❶, remove the chain tensioner ❷, hold on to the rear wheel while you pull out the axle passage ❸. Push the rear wheel as far to the front as possible, take the chain off of the rear sprocket and lay it on the rear sprocket guard. Carefully lift the rear wheel out of the swing arm.

! CAUTION !

- DO NOT OPERATE THE REAR BRAKE WHEN THE REAR WHEEL HAS BEEN DISMOUNTED.
- ALWAYS PLACE THE WHEEL ON THE GROUND WITH THE BRAKE DISC POINTING UPWARDS. OTHERWISE THE BRAKE DISC MAY BE DAMAGED.
- IF THE AXLE IS DISMOUNTED, CLEAN THE THREAD OF THE WHEEL SPINDLE AND COLLAR NUT THOROUGHLY AND APPLY A NEW COAT OF GREASE (MOTOREX LONG THERM 2000) TO PREVENT THE THREAD FROM JAMMING.

NOTE: Check the damping rubbers in the rear wheel hub when the rear wheel is dismounted.

Before remounting the rear wheel, clean and grease the bearing surface of the bushings ❹ and the shaft seal ring ❺.

The rear wheel is remounted in reverse order. Pay attention to the same mounting position of the axle passage and the chain tensioner and make sure the noses ❶ point to the front.

Before tightening the collar nut to 110 Nm, push the rear wheel forwards so that the chain tensioners lie on the tension screws.

⚠ WARNING ⚠

- IF YOU DON'T HAPPEN TO HAVE A TORQUE WRENCH AT HAND, MAKE SURE YOU HAVE THE TIGHTENING TORQUE CORRECTED BY A KTM DEALER AS SOON AS POSSIBLE. A LOOSE WHEEL SPINDLE MAY LEAD TO AN UNSTABLE DRIVING BEHAVIOR OF YOUR MOTORCYCLE.
- AFTER MOUNTING THE REAR WHEEL, KEEP OPERATING THE FOOTBRAKE UNTIL THE PRESSURE POINT RETURNS.
- IT IS VERY IMPORTANT TO KEEP THE BRAKE DISK FREE FROM OIL AND GREASE, OTHERWISE THE BRAKING EFFECT WOULD BE STRONGLY REDUCED.

Checking the shock absorption rubbers in the rear hub *

Adventure models have a damped rear wheel hub. For this purpose, the engine power is conveyed from the rear sprocket via 6 shock absorption rubbers ❻ to the rear wheel. These 6 absorption rubbers wear with increasing operation time, and should be checked for wear whenever the rear wheel is dismounted.

For this purpose, lie the rear wheel on a work bench with the rear sprocket upwards, and put the wheel spindle in the hub. Now hold the rear wheel firmly and try to turn the rear sprocket. The rear sprocket may not turn more than maximum 5 mm (0,2 in) measured on the outside. If the play in the chain wheel is larger, all 6 shock absorption rubbers are to be replaced. Check the shock absorption rubbers for signs of damage and dirt.

! CAUTION !

IF THE SHOCK ABSORPTION RUBBERS ARE NOT REPLACED IN GOOD TIME, THE REAR SPROCKET CARRIER AND THE REAR HUB WILL BE DAMAGED. ALWAYS REPLACE ALL 6 ABSORPTION RUBBERS, NEVER SINGLE RUBBERS.



TIRES - AIR PRESSURE		
950 Adventure	front	rear
Road, driver only	2,4 bar (34psi)	2,6 bar (37psi)
Road, with passenger	2,4 bar (34psi)	2,8 bar (40psi)
maximum payload	2,4 bar (34psi)	2,8 bar (40psi)

Tires, air pressure

Tire type, tire condition, and how much air pressure the tires have in them affect the way your motorcycle rides, and they must therefore be checked whenever you're getting ready to go anywhere on your motorcycle.



WARNING



- IN ORDER TO ENSURE RIDING SAFETY AND OPTIMAL RIDING PERFORMANCE, ONLY KTM-APPROVED TIRES MAY BE USED. OTHER TIRES CAN HAVE A NEGATIVE EFFECT ON RIDING PERFORMANCE (E.G. VIBRATION AT HIGHER SPEEDS).
- DO NOT EXCEED THE RESPECTIVE MAXIMUM SPEED FOR TIRES DESIGNED WITH A SPEED INDEX OF LESS THAN "V" (240 KPH, 150 MILES/H). A STICKER SHOWING THE MAXIMUM SPEED MUST BE AFFIXED TO THE MOTORCYCLE WITHIN THE DRIVER'S FIELD OF VISION.
- Tire type and size can be found in the technical specifications and in the homologation certificate
- Tire condition has to be checked every time you want to ride your motorcycle. Before leaving check for punctures and nails or other sharp objects that might have become embedded in the tire.
- Refer to the specific regulations in your country for minimum tire tread requirements. We recommend replacing tires at the latest when the tread is down to 2 mm (0.08 in).
- Tire pressure should be checked regularly on a "cold" tire. Adapt the air pressure to the motorcycle's total weight. Proper pressure ensures optimum driving comfort and extends the life of your tires.



WARNING



- DO NOT MOUNT TIRES WHICH HAVE NOT BEEN APPROVED BY KTM. OTHER TIRES COULD HAVE ADVERSE EFFECTS ON THE WAY YOUR MOTORCYCLE RIDES.
- USE TIRES OF THE SAME BRAND AND TYPE FOR THE FRONT AND REAR WHEELS.
- FOR YOUR OWN SAFETY REPLACE DAMAGED TIRES IMMEDIATELY.
- WORN TIRES CAN HAVE A NEGATIVE EFFECT ON HOW YOUR MOTORCYCLE PERFORMS, ESPECIALLY ON WET SURFACES
- IF AIR PRESSURE IS TOO LOW, ABNORMAL WEAR AND OVERHEATING OF THE TIRE CAN RESULT
- NEW WHEELS HAVE A SMOOTH SURFACE, WHICH MEANS THAT THEY MUST BE RUN IN TO ACHIEVE FULL GRIP. FOR THIS PURPOSE, RIDE THE MOTORCYCLE CAREFULLY AT MODERATE SPEED DURING THE FIRST 200 KILOMETERS (125 MILES) WITH NEW TIRES, TILTING THE VEHICLE AT DIFFERENT ANGLES SO THAT ALL SECTIONS ARE PROPERLY ROUGHENED. TIRES WILL NOT DISPLAY THEIR FULL GRIP CHARACTERISTICS UNTIL THEY ARE PROPERLY RUN IN.
- FOR REASONS OF SAFETY, IT IS RECOMMENDED TO EXCHANGE THE VALVE INSERT WHENEVER A NEW TIRE IS MOUNTED.



Checking spoke tension

The correct spoke tension is very important for the stability of the wheels and thus for riding safety. A loose spoke causes the wheel to become unbalanced and before long other spokes will have come loose. Check spoke tension, especially on a new motorcycle, in regular intervals. For checking, tap on each spoke with the blade of a screw driver (see illustration). A clear tone must be the result. Dull tones indicate loose spokes. If necessary, have the spokes retightened and the wheel centered by a KTM dealer.



WARNING



- IF YOU CONTINUE TO DRIVE WITH LOOSE SPOKES, THE SPOKES CAN TEAR AND LEAD TO AN INSTABLE HANDLING PERFORMANCE. TORN SPOKES CAN DAMAGE THE AIR HOSE. THE LOSS OF AIR CAN EASILY CAUSE THE MOTORCYCLE TO GO OUT OF CONTROL.
- EXCESSIVELY TENSIONED SPOKES MAY RUPTURE DUE TO LOCAL OVERLOADING. THE SPOKES MUST BE TENSIONED TO 4 - 6 NM.



Battery

The battery is located in the underride protection in front of the engine and is maintenance-free. It is not necessary to check the electrolyte level or to refill water. Simply keep the battery poles clean and slightly grease them with an acid-free grease if necessary.



CAUTION



NEVER REMOVE THE CLOSING COVER ❶ OTHERWISE THE BATTERY WILL BE DAMAGED.

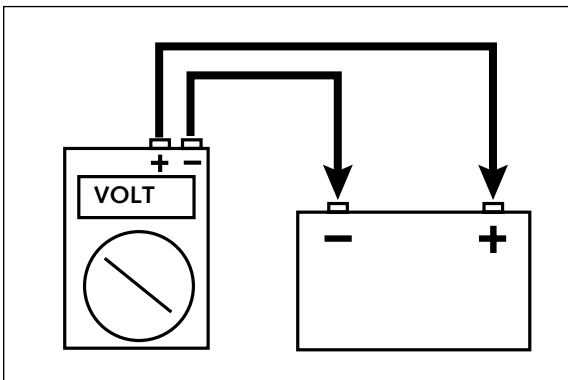
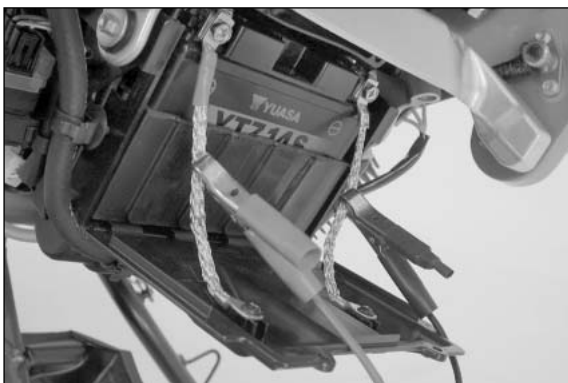
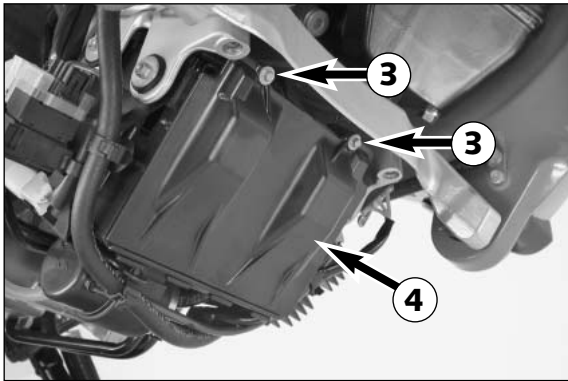
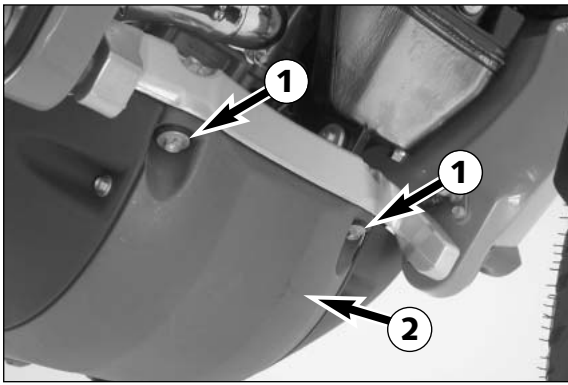

Demounting and mounting the battery *

The battery does not need to be demounted unless the motorcycle is being immobilized.

To demount the battery, remove the screws ❶ and fold the underride protection ❷ down. Remove the screws ❸ and tilt the battery cover ❹ to the front. First disconnect the negative pole and then the positive pole. Remove the battery cover and remove the battery together with the battery case.

Recharge the battery before and after storage. Storage temperature: 0 - 35°C (32 - 95°F).

To mount, place the battery and battery case in the battery compartment and mount the battery cover. First connect the positive pole, then the negative pole to the battery to avoid a short circuit. Fold the battery cover up and fasten with 2 screws. Fold the underride protection up, apply Loctite 243 (screw retainer) to both screws, mount the screws and tighten to 25 Nm (19 ft.lbs).



WARNING



- IF ELECTROLYTE (SULPHURIC ACID) LEAKS FROM THE BATTERY, PROCEED WITH GREAT CARE. THE ELECTROLYTE CAN CAUSE SEVERE BURNS.
- IN THE CASE OF SKIN CONTACT RINSE THOROUGHLY WITH WATER.
- IN THE CASE OF CONTACT WITH THE EYES, THOROUGHLY RINSE EYES WITH WATER FOR AT LEAST 15 MINUTES. IMMEDIATELY CONSULT A DOCTOR.
- THE BATTERY IS A CLOSED MODEL BUT CAN NEVERTHELESS EMIT EXPLOSIVE GASES. AVOID SPARKS AND OPEN FIRE NEAR THE BATTERY.
- DEFECTIVE BATTERIES MUST BE STORED OUT OF THE REACH OF CHILDREN. ENSURE PROPER DISPOSAL OF DISCARDED BATTERIES.
- THE SCREWS FROM THE UNDERRIDE PROTECTION MUST BE SECURED WITH LOCTITE 243 TO PREVENT THEM FROM BECOMING LOOSE.



CAUTION



NEVER DISCONNECT THE BATTERY WHILE THE ENGINE IS RUNNING. THIS WILL DESTROY THE RECTIFIER-REGULATOR.

Charging the battery

NOTE: a battery charger, item no. 58429074000, is available from your KTM dealer. You can also use the battery charger to test the off load voltage, startability of the battery and the generator capacity.

Fold the underride protection and the battery cover down and check the batter's charging condition. Use a voltmeter to measure the voltage between the battery poles (off-load voltage).

Accurate results can only be obtained if the battery has neither been charged nor discharged during a period of 30 minutes preceding the measuring. Recharging is not required if the voltage exceeds 12.4 V.

Recharge if the voltage is below 12.4 V.

CHARGING:

Connect the battery charger to the cables ❺ leading to the battery cover. These cables were mounted since the battery poles are hard to reach and short circuits easily occur when handled.

Charge the battery for 5 to a max. of 10 hours with 1,4 amperes and a max. of 14.4 volts.

For a quick charge, do not charge the battery longer than 1 hour with 4.5 amperes and a max. of 14.4 volts.



CAUTION



- IF THE CHARGE CONDITION CANNOT BE ESTABLISHED, THE BATTERY MAY ONLY BE CHARGED 5 TO A MAX. OF 10 HOURS WITH 1.4 AMPERES AND A MAX. OF 14.4 VOLTS.
- ALWAYS CONNECT THE BATTERY TO THE CHARGING UNIT BEFORE TURNING THE CHARGING UNIT ON.
- WHEN RECHARGING THE BATTERY IN CLOSED ROOMS THERE IS SUFFICIENT VENTILATION. EXPLOSIVE GASES ARE RELEASED DURING THE BATTERY CHARGING PROCESS.
- CHARGING TIME AND CHARGING VOLTAGE SHOULD NOT EXCEED THE STATED VALUES. OTHERWISE ELECTROLYTE WILL BE RELEASED THROUGH THE SAFETY VALVES.
- AVOID QUICK CHARGING IF POSSIBLE.
- TO AVOID DAMAGE, DO NOT REMOVE THE LOCKING BAR.

Connecting the battery jumper cable

Fold the underride protection and the battery cover down (see demounting and mounting the battery). Connect the battery jumper cable to the cables leading to the battery-cover. Connect the positive battery cable first.



CAUTION



- DO NOT ALLOW THE BARE PARTS OF THE JUMPER CABLE TO COME INTO CONTACT WITH EACH OTHER. A SHORT CIRCUIT CAN DAMAGE THE ELECTRIC SYSTEM OF BOTH VEHICLES.
- ONLY CONNECT THE BATTERIES BRIEFLY TO AVOID OVERLOADING.

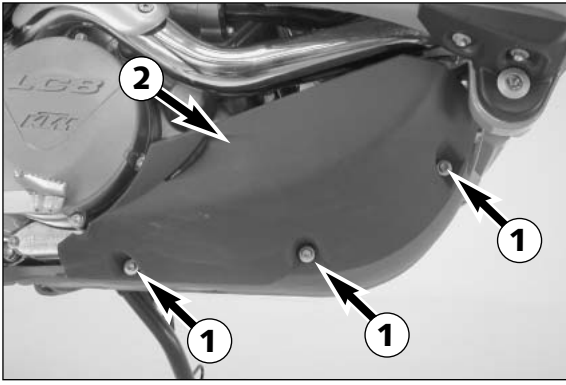

Main fuse

The main fuse protects all of the motorcycle's current consumers. The main fuse is located in the starter relay under the right engine cowl. Remove the screws 1 and take off the engine cowl 2.

WARNING

DO NOT BURN YOURSELF ON THE HOT EXHAUST PIPE.

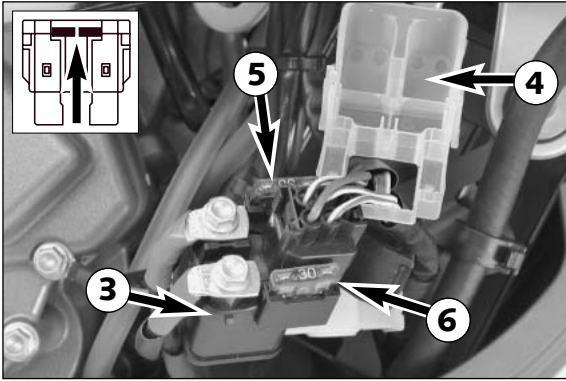

Lift the starter relay 3 out of the bracket, remove the cap 4 and check the main fuse 5. A spare fuse 6 (30 ampere) is also plugged into the starter relay.

Replace a blown fuse only with an equivalent one. If a new fuse that has just been set in gets blown again, you are strongly advised to have it inspected by a KTM dealer.

CAUTION

UNDER NO CIRCUMSTANCES IS A STRONGER FUSE ALLOWED TO BE SET IN OR A FUSE ALLOWED TO BE "REPAIRED". AN INEXPERT TREATMENT COULD DAMAGE THE WHOLE ELECTRICAL INSTALLATION!

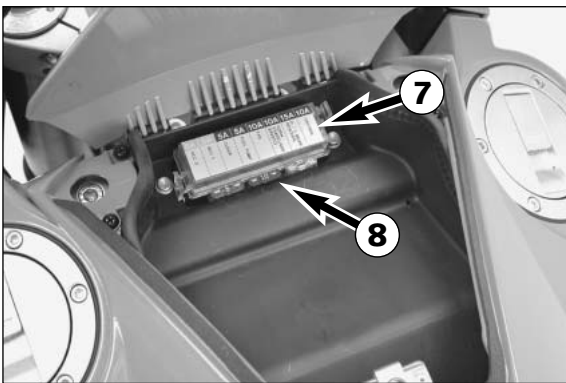

Fuses for individual current consumers

A fuse box with additional fuses is mounted in the storage compartment to separately protect the current consumers against short circuits.

The current consumers and the corresponding fuse capacities are listed on the cover of the fuse box 7. The fuse box also contains 5, 10 and 15-ampere spare fuses 8.



Replace a blown fuse only with an equivalent one. If a new fuse that has just been set in gets blown again, you are strongly advised to have it inspected by a KTM dealer.

CAUTION

UNDER NO CIRCUMSTANCES IS A STRONGER FUSE ALLOWED TO BE SET IN OR A FUSE ALLOWED TO BE "REPAIRED". AN INEXPERT TREATMENT COULD DAMAGE THE WHOLE ELECTRICAL INSTALLATION!

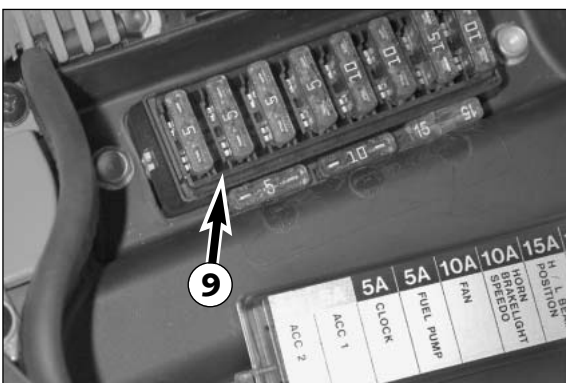

The ACC 1 and ACC 2 fuses 9 are not allocated to specific current consumers in the condition at delivery. They are designed for accessory equipment with a maximum current consumption of 5 amperes each. The respective connectors for this equipment are provided under the headlight cover. For more information, contact an authorized KTM workshop.

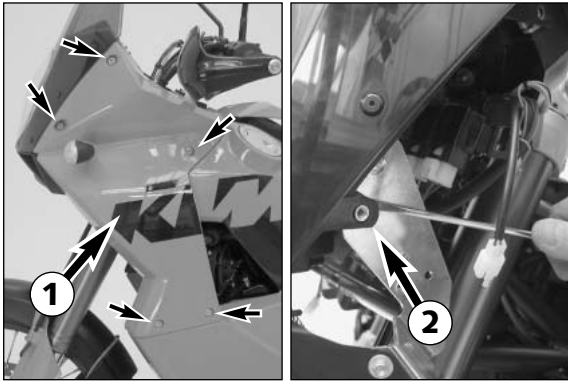

Replacing the headlight lamps *

Remove the 5 screws on the left and right and take off both side covers ①. Use a screwdriver to detach the retaining tabs ②, tilt the windshield and headlight forward and pull the connector off the connector support. Place the headlight on a soft pad to keep it from being damaged.

! CAUTION !

NEVER TOUCH THE GLASS OF THE BULB WITH YOUR FINGERS. THE GLASS OF THE BULB MUST REMAIN ABSOLUTELY FREE FROM GREASE. HEAT WILL OTHERWISE CAUSE THE GREASE TO EVAPORATE AND SETTLE DOWN ON THE REFLECTOR.

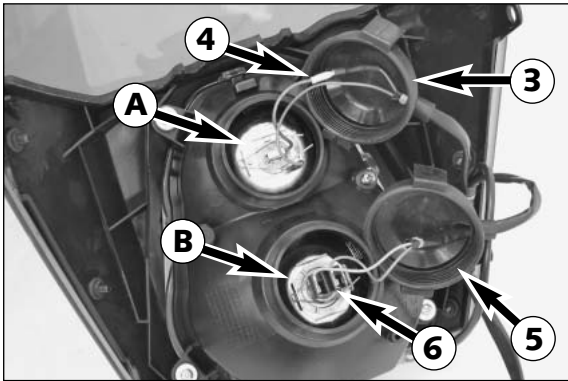

HIGH BEAM BULB A :

Remove the rubber cap ③ and pull off the connector ④. Detach the retaining clip and remove the bulb.

Fit the retaining clip, connect the connector and mount the rubber cap.

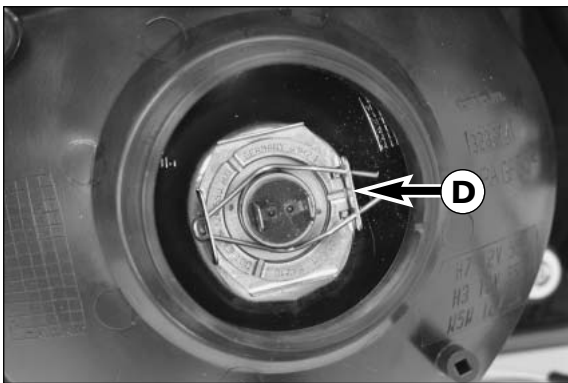

LOW BEAM BULB B :

Remove the rubber cap ⑤ and pull off the connector ⑥. Detach the retaining clip and remove the bulb.

When inserting the new bulb, make sure tab ① is firmly seated in the socket recess.

Fit the retaining clip, connect the connector to the bulb and mount the rubber cap.

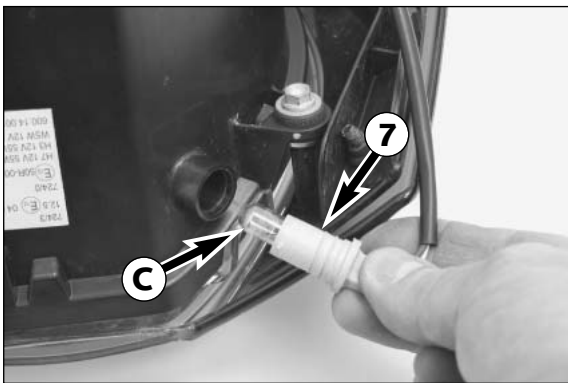

PARKING LIGHT BULB C :

Pull the bulb socket ⑦ out of the reflector and pull the bulb out of the bulb socket.

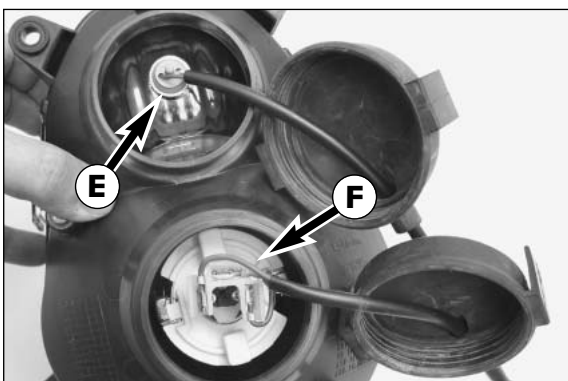

USA design:

The parking light E is located in the upper part of the headlight in the USA design. E bulb F with high and low beams is mounted in the lower part of the headlight.

Connect the connectors to the connector support to check all of the bulbs for proper functioning before you remount the headlight.

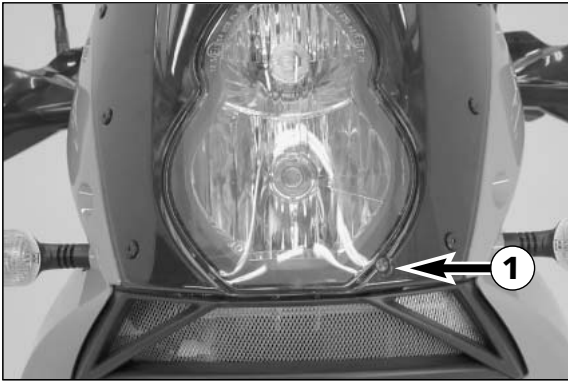

Adjusting the headlight range

The payload can make it necessary to correct the headlight range. The headlight range can be adjusted with the adjusting screw ①. Turning in a clockwise direction will increase the headlight range, turning in a counterclockwise direction will reduce the headlight range.

TO CHECK:

Make a mark on a light wall behind a level surface at a height of 850 mm (33.5 in) (950 Adventure S) or 810 mm (31.9 in) (950 Adventure) respectively. Position your motorcycle loaded ready for the trip (baggage, driver, passenger) 10 meters away from the wall and switch on the low beam. The light/dark cut-off line should be at the mark.

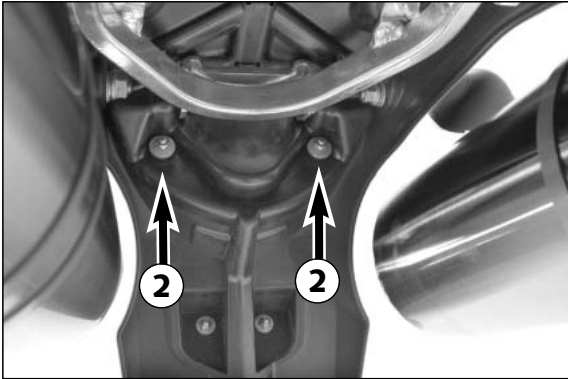

Replacing the brake and tail light bulbs

Remove the hexagon nuts ② on the bottom of the fender and pull the tail light off towards the rear.

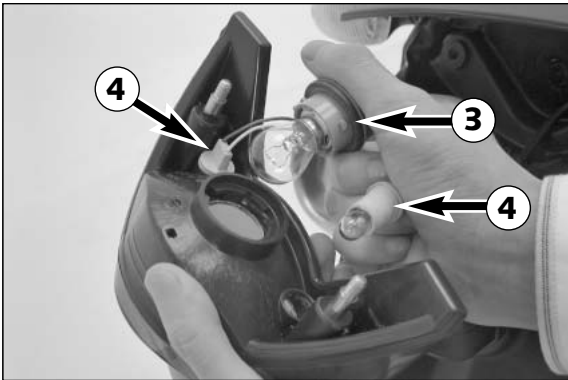

BRAKE LIGHT BULB:

Turn the lamp socket ③ approximately 30° counterclockwise and pull it out of the tail light housing. Slightly depress the bulb, turn it approx. 30° counterclockwise and pull it out of the socket. To mount the lamp reverse the worksteps indicated above.

TAIL LIGHT BULBS:

Pull the socket ④ out of the housing and pull the bulb out of the socket.

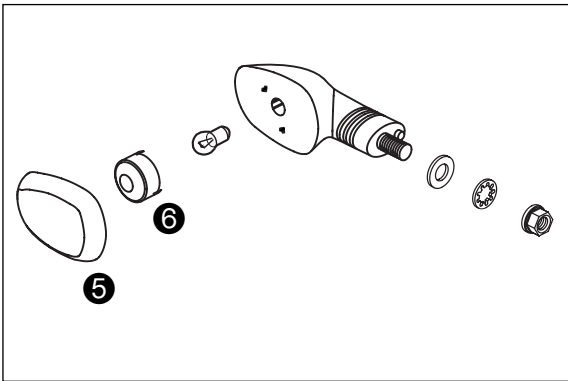

Replacing the flasher bulbs

Remove the screw on the back of the turn signal, carefully fold the lens ⑤ towards the motorcycle and remove. Turn the cap ⑥ approx. 15° in a counterclockwise direction and remove.

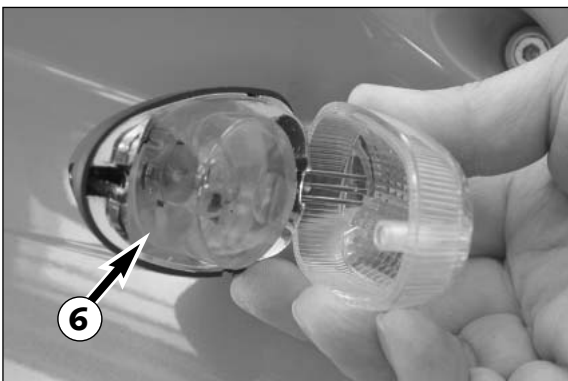

Slightly depress the bulb, turn it approx. 30° counterclockwise and pull it out of the socket. To mount the lamp reverse the worksteps indicated above.

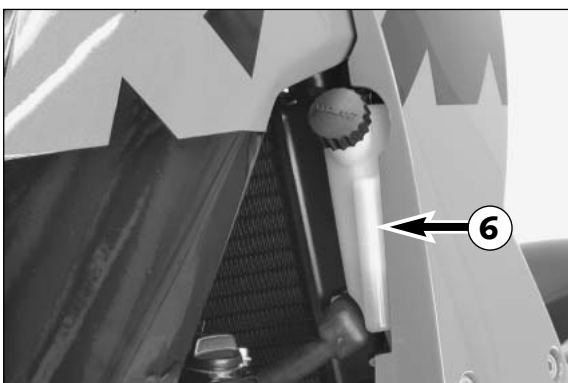
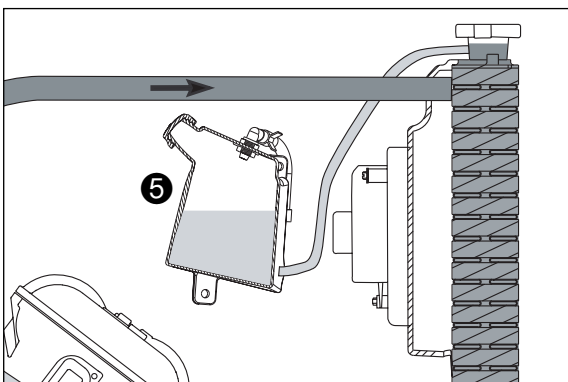
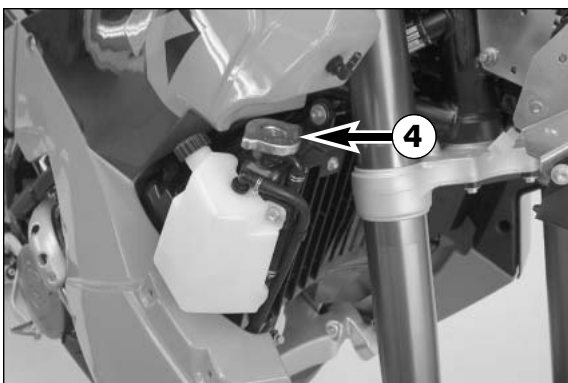
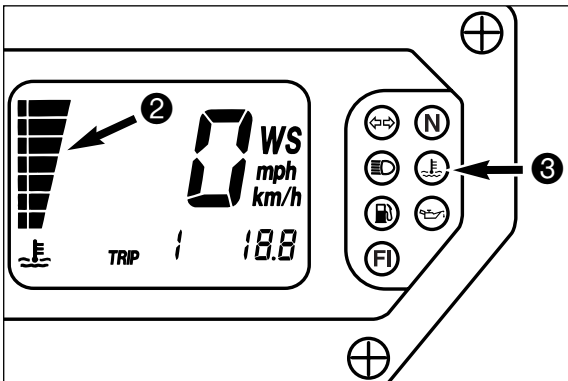
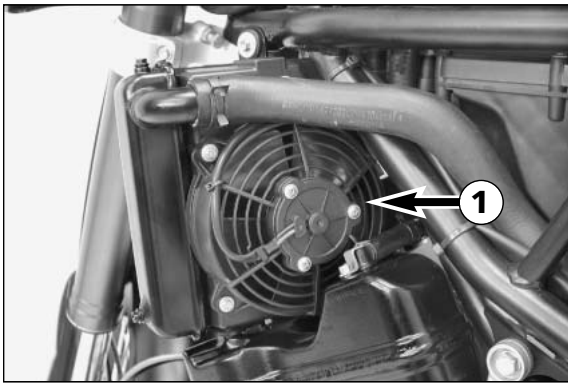

Cooling system

The water pump in the engine ensures a forced circulation of the cooling liquid. When the engine is cold, the cooling liquid only circulates in the cylinders and cylinder heads. After the engine reaches the operating temperature (approx. 75°C, 167°F), the thermostat opens and the cooling liquid is also pumped through the aluminum radiator.

Cooling is by means of the air stream. The lower the speed, the lower the cooling effect. Soiled cooling fins also impair the cooling effect.

If, for example, slow urban traffic or waiting at a traffic light cause little or no air to stream through the radiator, the temperature of the cooling liquid will rise. The radiator fan ① switches on when the cooling liquid reaches a temperature of 102°C (216°F). Additional air is blown through the radiator to prevent the cooling system from overheating.

! CAUTION !

THE TEMPERATURE INDICATOR ② WILL BEGIN TO BLINK AND THE RED COOLING LIQUID TEMPERATURE WARNING LAMP ③ WILL LIGHT UP WHEN THE COOLING LIQUID REACHES APPROX. 120°C (248°F), HAVING EXCEEDED THE NORMAL OPERATING TEMPERATURE.

POSSIBLE CAUSES:

- SLOW RIDING WITH LARGE LOADS AT A HIGHER AIR TEMPERATURE:
IF POSSIBLE INCREASE YOUR RUNNING SPEED, SO THAT MORE AIR CAN BLOW THROUGH THE RADIATORS. SHOULD THE WARNING LIGHT STILL BE ON OFF AFTER 1500 METERS (1 MILE), STOP IMMEDIATELY, SWITCH OFF THE ENGINE AND LOOK FOR OTHER POSSIBLE CAUSES.
- THE COOLING FAN ON THE RADIATOR IS NOT WORKING:
THE COOLING FAN MUST BE RUNNING, WHEN THE COOLING LIQUID TEMPERATURE IS 120°C (248°F) AND THE IGNITION IS ON. IF THE FAN IS NOT WORKING, AND THERE APPEARS TO BE SUFFICIENT COOLING LIQUID, THE ONLY THING YOU CAN DO IS TO DRIVE ON TO YOUR NEAREST AUTHORIZED KTM WORKSHOP AT THE LEAST POSSIBLE ENGINE LOAD.
- TOO LITTLE COOLING LIQUID IN THE SYSTEM:
CHECK WHETHER ANY COOLING LIQUID IS LEAKING OUT (ALSO ON THE BOTTOM OF THE MOTORCYCLE).
LET THE ENGINE COOL DOWN AND CHECK THE COOLING LIQUID LEVEL IN THE RADIATOR (SEE CHAPTER CHECKING THE COOLING LIQUID LEVEL IN THE RADIATOR). ONLY CONTINUE TO DRIVE IF THERE IS ENOUGH COOLING LIQUID IN THE SYSTEM. CONTACT AN AUTHORIZED KTM WORKSHOP TO HAVE THE ERROR ELIMINATED. YOU WILL DAMAGE THE ENGINE IF YOU CONTINUE TO DRIVE WHEN THE COOLING LIQUID TEMPERATURE WARNING LAMP IS ON.
- EXCESSIVE USE OF THE CLUTCH AT SLOW SPEED

A mixture of 40% antifreeze and 60% distilled water is used as the cooling liquid. However, the anti-freeze protection must be at least -25° C (-13° F). Aside from antifreezing protection, this mixture also provides great corrosion protection which is why it must not be replaced by pure water.

! CAUTION !

- FOR THE COOLING SYSTEM, USE ONLY HIGH-GRADE ANTIFREEZER (MOTOREX ANTI-FREEZE). USING LOWERGRADE ANTIFREEZE AGENTS, CAN CAUSE CORROSION AND COOLANT FOAMING.
- MORE ANTIFREEZE MUST BE ADDED IF YOU PLAN TO TRAVEL TO A REGION WHERE TEMPERATURES ARE EXPECTED TO DROP BELOW -25°C (-13°F).

Pressure induced by heating of the cooling liquid in the cooling system is controlled by a valve in the radiator cap ④; a water temperature rising up to 125° C (257° F) is admissible, without fear of problems.

Any excess cooling liquid caused by thermal expansion is conducted to the compensating tank ⑤. It will be sucked back in as soon as the temperature in the cooling system drops.

Checking the cooling liquid level in the compensating tank

Check the level of the cooling liquid when the engine is cold. It should fall between the MIN and MAX marks on the compensating tank ⑥.

Add cooling liquid (see above for mixture ratio) if the cooling liquid level drops below the MIN mark.

If you need to add cooling liquid quite often, the cooling system may leak. If the compensating tank is empty, also check the cooling liquid level in the radiator. Have the cooling system checked by an authorized KTM workshop.

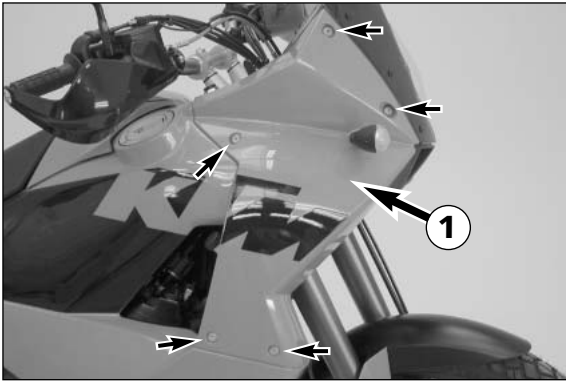

Checking the cooling liquid level in the radiator

Remove the 5 screws, take off the right panel ① and disconnect the turn signal cable.

⚠ **WARNING** ⚠

IF POSSIBLE, ALWAYS CHECK LEVEL OF COOLING LIQUID WHEN ENGINE IS COLD. IF YOU HAVE TO OPEN THE RADIATOR CAP WHEN ENGINE IS HOT, USE A RAG TO COVER THE CAP AND OPEN SLOWLY TO RELEASE PRESSURE.

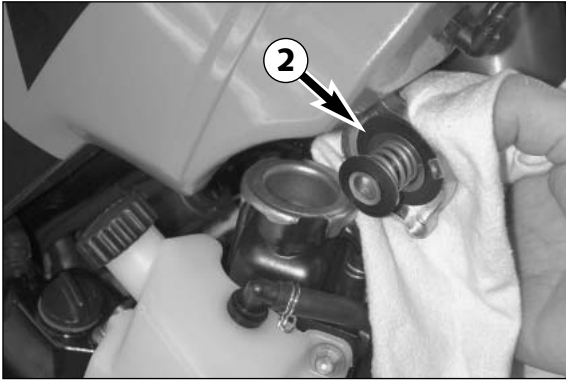

Carefully remove the radiator cap ② with a rag, turning in a counterclockwise direction. The radiator should be completely filled with cooling liquid. No air should be in the radiator.

If any cooling liquid is missing, the cooling system may leak. Have the cooling system checked by an authorized KTM workshop.

! **CAUTION** !

IF MORE THAN 1 LITER (0.26 USGAL) OF COOLING LIQUID NEEDS TO BE ADDED, THE COOLING SYSTEM MUST BE BLED.

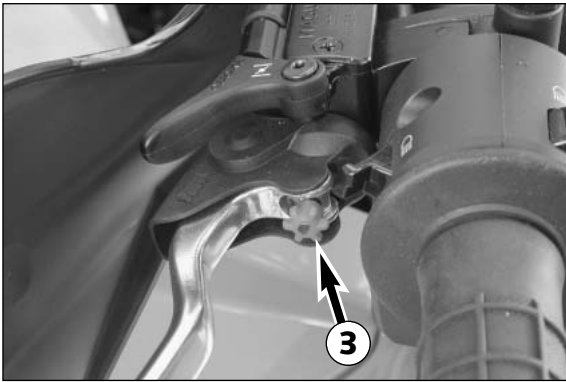

Changing the original position of the clutch lever

The adjusting screw ③ can be used for individual adjustment of the original position of the clutch lever, thus allowing adjustment to an optimal position for every hand size.

Turning the adjusting screw clockwise reduces the distance between the clutch lever and the handlebar. Turning the adjusting screw counterclockwise increases the distance between the clutch lever and the handlebar.

! **CAUTION** !

ADJUSTMENT OF THE CLUTCH LEVER POSITION IS ONLY POSSIBLE WITHIN CERTAIN LIMITS. ONLY TURN THE ADJUSTING SCREW MANUALLY AND NEVER APPLY EXCESSIVE FORCE.

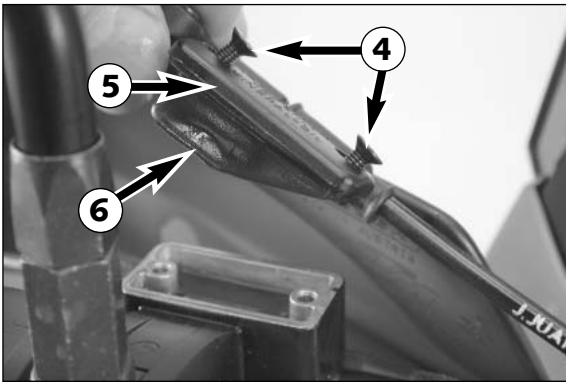

Checking the oil level of the hydraulic clutch

To check the oil level in the master cylinder of the clutch remove the cover. For this purpose, remove screws ④ and cover ⑤ together with the rubber boot ⑥. The oil level in the horizontal-standing master cylinder should be 4 mm below the upper edge.

If necessary, add SAE 10 biodegradable hydraulic oil (Motorex clutch fluid 75), available from your authorized KTM workshop.

! **CAUTION** !

KTM USES BIODEGRADABLE HYDRAULIC OIL FOR THE HYDRAULIC CLUTCH CONTROL. NEVER MIX BIODEGRADABLE HYDRAULIC OILS WITH MINERAL OILS. NEVER REFILL WITH MINERAL HYDRAULIC OIL OR BRAKE FLUID.

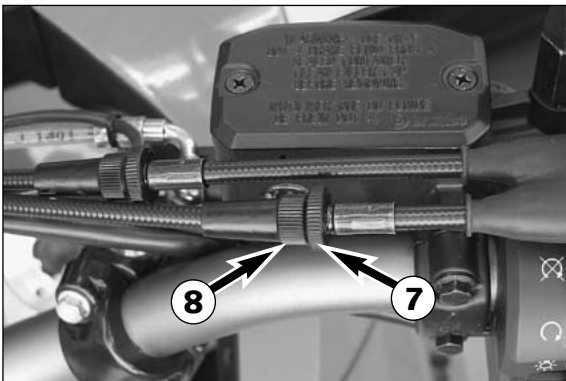

Checking and adjusting the throttle cable play *

When starting to turn the throttle grip, you should feel an initial backlash of 3-5 mm (0.12-0.2 in).

To adjust, loosen the counter nut ⑦, turn the adjusting screw ⑧ as needed and tighten the counter nut again.

Make sure that the throttle grip will return to the idle position automatically once you let go of it.

To check the correctness of this setting, start the engine, turn the handlebar left and right, in both cases as far as it will go. This must not cause any changes in idling speed. Otherwise, you have to increase the backlash of the throttle cable.

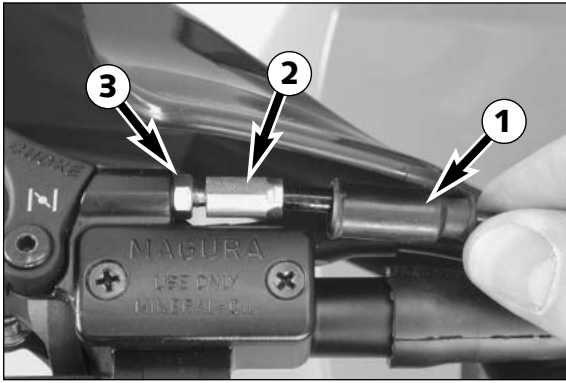

Checking and adjusting the choke cable play *

The choke cable must have a play of approx. 3 mm (0.12 in) at all times. To check the play, push back the protection cover ①. It should be possible to lift the cable approx. 3 mm away from the adjusting screw ②. If necessary, loosen the counter nut ③, turn the adjusting screw as needed, tighten the counter nut again and slide on the protection cover.

! CAUTION !

IF THERE IS NO PLAY IN THE CHOKE CABLE, THE BORE OF THE COLD STARTER SYSTEM CANNOT BE COMPLETELY CLOSED. THIS RESULTS IN HIGH FUEL CONSUMPTION, AN UNEVEN RUNNING ENGINE, AND AN EXTREME WEAR OF PISTON AND CYLINDER.

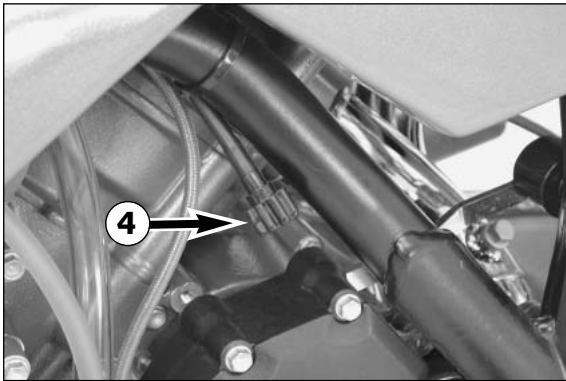

Adjusting the engine idle speed

The idle speed should be 1400/min when the engine is warm. The idle speed can be adjusted with the adjusting knurl ④ near the left frame tube. Turning in a clockwise direction will increase the idle speed, turning in a counterclockwise direction will reduce the idle speed.

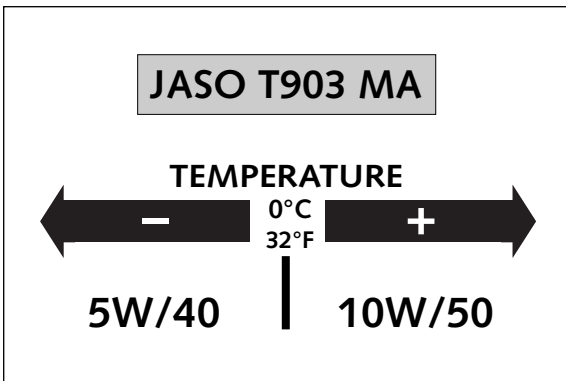

Engine oil

Automobile engine oil used to be used for four-stroke motorcycles before there were separate motorcycle specifications. Different technical developments made it necessary to have a separate specification for four-stroke motorcycles - the JASO T903 MA standard. Whereas car engines require long changing intervals, motorcycle engines require a higher power output at higher speeds. Most motorcycle engines also use the same oil to lubricate the transmission and the clutch. The JASO MA standard responds to these special requirements.

Only use fully synthetic engine oils that meet the JASO MA quality requirements (see information on the can).

KTM recommends Motorex Power Synt 4T in the 10W/50 viscosity (for temperatures over 0°C, 32°F) or 5W/40 (for temperatures under 0°C, 32°F).

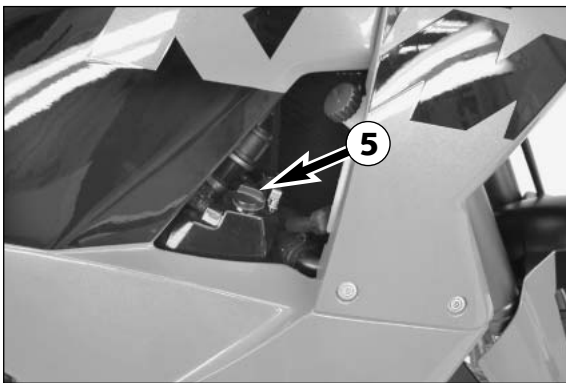

Checking the engine oil level

Check the engine oil level when the engine is warm (at least 4 bars on the temperature indicator light up). Allow the warm engine to run idle for approx. 1 minute and motorcycle place the motorcycle on a level surface (not on the side stand).

Turn off the engine, unscrew the oil dipstick ⑤ and wipe off with a cloth. **Screw the oil dipstick all the way back in and back out again.**

The oil level should fall between the lower end of the oil dipstick (MIN) and the MAX mark.

The oil capacity between the MIN and MAX mark is 0.5 liters (0.13 USgal). Add more engine oil if necessary and check the engine for leakage.

! CAUTION !

- INSUFFICIENT AMOUNTS OF OR LOW-GRADE ENGINE OIL LEAD TO PREMATURE WEAR IN THE ENGINE.
- DO NOT OVERFILL THE ENGINE CASE.
- DO NOT UNDERFILL THE ENGINE CASE.



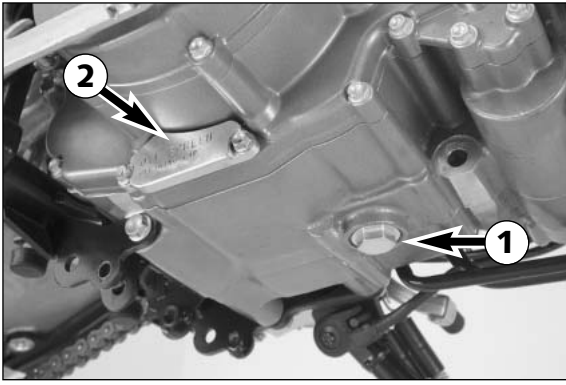

Changing the engine oil and the oil filter, cleaning the oil screen *

NOTE: The LC8 engine has a dry-sump lubrication system. The engine oil is pumped from the oil sump in the engine case to the oil tank. The engine oil must also be drained from the oil tank during an oil change. Since many parts must be demounted for an oil change, we recommend having the engine oil changed by an authorized KTM workshop.

During the guaranty period, the oil change must be performed by an authorized KTM mechanic. Otherwise, the guarantee will become void.

The engine oil change is to be carried out when the engine is still warm.



WARNING



AN ENGINE HAVING BEEN RUN WARM, AND THE ENGINE OIL IN IT IS VERY HOT - DO NOT BURN YOURSELF.

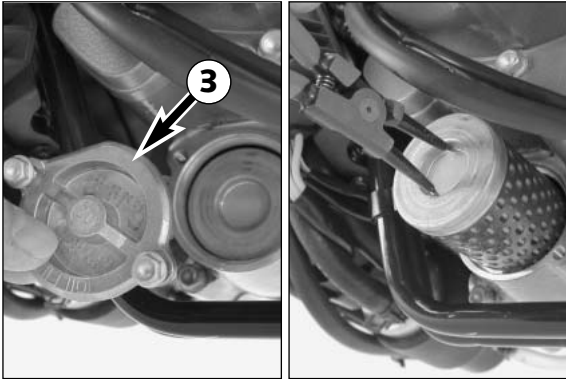

Place the motorcycle on a level surface. Remove the 4 screws, take off the underside protection and place a receptacle for the used oil under the engine. Remove the oil drain plug ①, take off the cap ② and pull the oil sieve out of the engine case with a pair of pliers.

Remove the oil filter cover ③ and pull the oil filter out of the engine case with circlip pliers (upside-down).

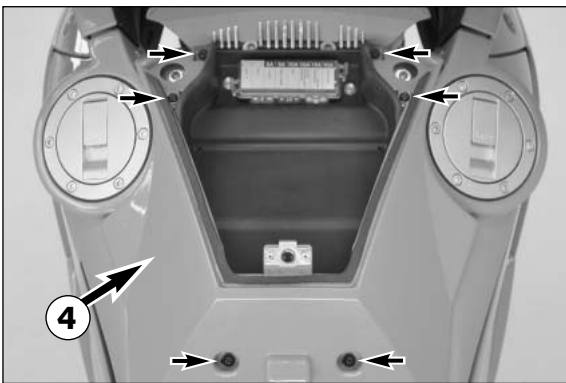

Remove the 6 screws and the cover ④.

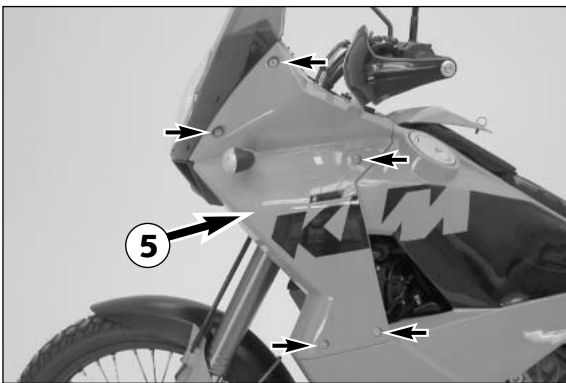

Remove the ⑤ screws, take off the left panel 5 and disconnect the turn signal cable.

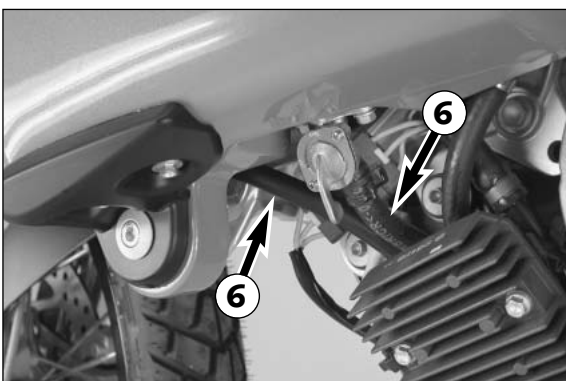

Close all 3 fuel taps and the disconnect the fuel lines ⑥ from the left tank.

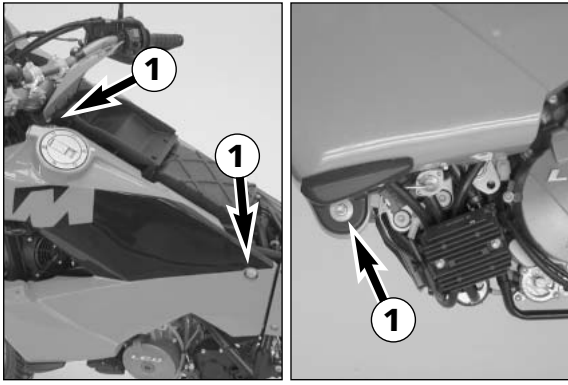

Remove the 3 screws **1**, lift the tank approx. 15 mm and carefully tilt to the side. Disconnect the connector from the pickup cable (fuel level) and set the tank down.

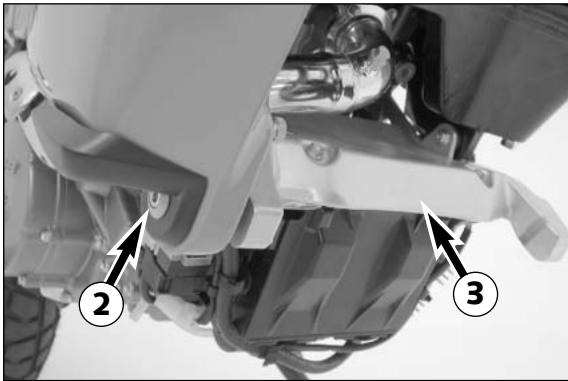

Remove the lower screw **2** on the right tank. Remove the HH screws and take off the battery cover **3**.

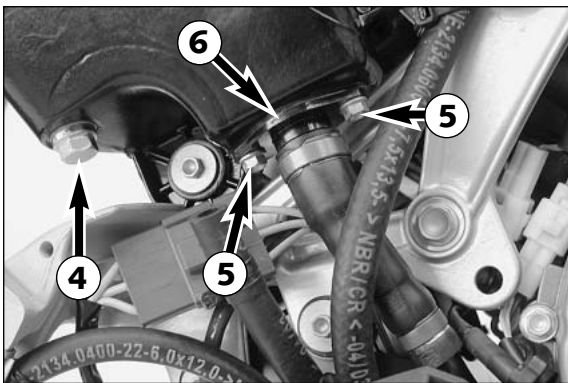

Remove the drain plug **4** on the oil tank and allow the oil to drain into a receptacle. Remove the screws **5** and tilt the oil return valve **6** to the side.

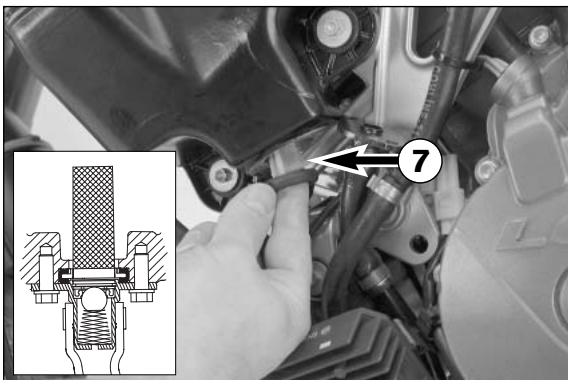

Carefully pull the oil screen **7** out of the oil tank.

Thoroughly clean the drain plugs, the cover and both oil screens. Clean all rubber seal rings and check for damage. Replace if necessary.

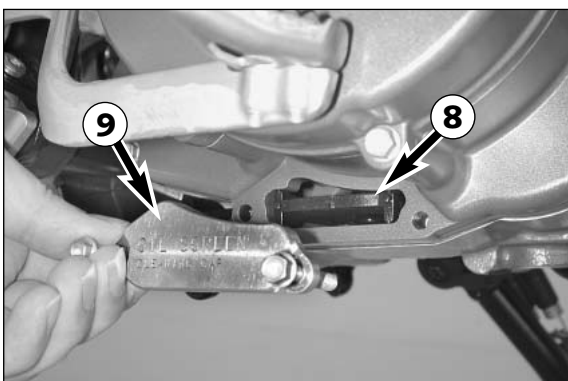

Mount the oil drain plug on the engine with a new seal ring and tighten to 20 Nm.

Slide the oil screen **8** into the guides in the oil pump housing with the TOP mark facing up. Make sure the form ring is in place and mount the cap **9**. Tighten the screws to 10 Nm.

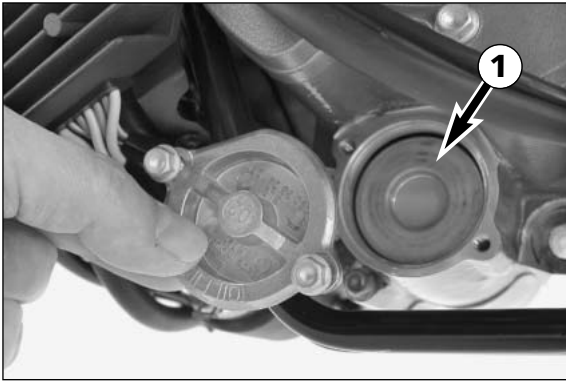

Insert a new oil filter ❶ in the engine case, grease the O-ring and mount the oil filter cover together with the O-ring. Tighten the screws to 6 Nm.

! CAUTION !

ONLY USE ORIGINAL KTM OIL FILTERS. THE ENGINE CAN BE DAMAGED IF OTHER FILTERS ARE USED.

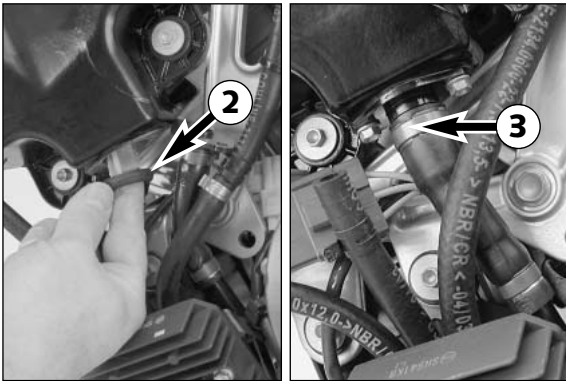

Mount the oil drain plug on the oil tank with a new seal ring and tighten to 20 Nm.

Grease the seal ring ❷ and carefully slide the oil screen into the oil tank. Position the oil return valve ❸, mount the screws and tighten to 10 Nm.

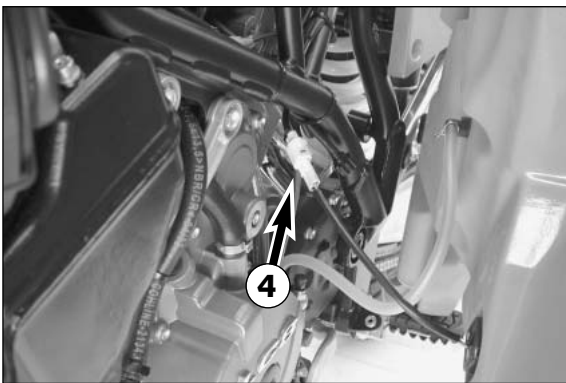

Mount the battery cover and tighten the screws to 25 Nm. Mount the lower screw on the right tank and tighten to 25 Nm.

Connect the pickup cable ❹ to the left tank and fasten the tank with 3 screws. Tighten the screws to 25 Nm. Connect the fuel lines and open all 3 fuel taps.

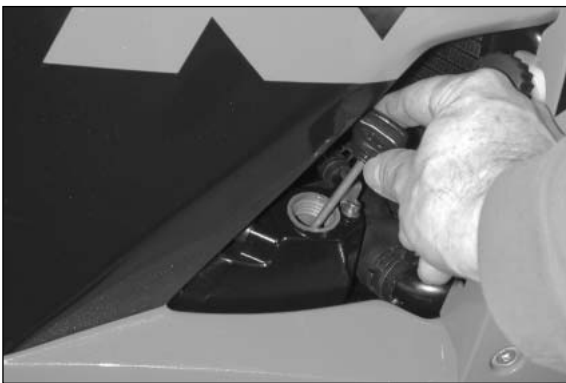

Add 2.5 liters (0.7 USgal) of fully synthetic engine oil meeting the JASO MA standard (e.g. Motorex Power Synt 4T) and mount the oil dipstick. Start the engine, allow to run warm for 4 minutes and switch off the engine. Remove the oil dipstick and add engine oil up to the MAX mark (approx. 0.5 liters, 0.13 USgal).

Check the engine and the oil tank for oil leakage.



Apply Loctite 243 to the thread of the 4 screws, mount the underride protection and tighten the screws to 25 Nm.

⚠ WARNING ⚠

THE SCREWS ON THE UNDERRIDE PROTECTION MUST BE SECURED WITH LOCTITE 243 TO PREVENT THEM FROM BECOMING LOOSE.

Connect the turn signal cable and the tank vent hose and mount the left panel. Mount the storage compartment cover.



Activating the ignition curve for low-octane fuel

If you are traveling to a country where fuel having at least 95 octane (ROZ) is not available, you can easily activate the corresponding ignition curve.

A plug and socket connection ❶ on a brown/black cable is located near the upper shock absorber holder .

If the two connectors are connected to each other, the ignition curve for fuel having at least 95 octane (ROZ) is activated.

If you disconnect the plug and socket connection, the ignition curve for fuel having 80 - 94 octane (ROZ) is activated. Although this causes the engine to lose some of its power output, it prevents poor glow ignitions and engine damage.

!

CAUTION

!

IF FUEL HAVING AT LEAST 95 OCTANE (ROZ) IS NOT AVAILABLE, THE IGNITION CURVE FOR 80 - 94 OCTANE (ROZ) MUST BE ACTIVATED TO PREVENT ENGINE DAMAGE.

TROUBLE SHOOTING

If you let the specified maintenance work on your motorcycle be carried out, disturbances can hardly be expected. Should an error occur nevertheless, we advise you to use the trouble shooting chart in order to find the cause of error. We would like to point out that many operations cannot be performed by oneself. In case of uncertainty, please contact a KTM-dealer.

TROUBLE	CAUSE	REMEDY
Engine does not start when the starter button is actuated	<p>Operating error</p> <p>Discharged battery.</p> <p>Blown fuse IGNITION.</p> <p>Blown main fuse.</p> <p>Defect ignition lock or emergency OFF switch</p> <p>Defect safe-starting system.</p>	<p>Turn on the ignition, switch the gear to neutral and switch the emergency OFF switch on.</p> <p>Recharge the battery and investigate the causes for discharging; contact an authorized KTM workshop.</p> <p>Replace fuse IGNITION</p> <p>Remove the engine cowl and replace the main fuse in the starter relay</p> <p>Check ignition lock and emergency OFF switch, contact an authorized KTM workshop.</p> <p>Contact an authorized KTM workshop.</p>
The engine cranks only with pulled clutch lever	<p>A gear is engaged</p> <p>A gear is engaged and the side stand is still folded down</p> <p>Defect safe-starting system.</p>	<p>Shift the transmission to neutral.</p> <p>Shift the transmission to neutral.</p> <p>Contact an authorized KTM workshop.</p>
Engine cranks with gear engaged.	<p>Defect safe-starting system.</p>	<p>Contact an authorized KTM workshop.</p>
Engine cranks but doesn't start.	<p>Operating error</p> <p>Blown fuse for the fuel pump</p> <p>The plug and socket connector on the wiring harness is oxidized</p>	<p>Open fuel taps, tank fuel, you did not use choke. Pay attention to starting off information (see driving instructions).</p> <p>Replace the FUEL PUMP fuse</p> <p>Remove the panel and fuel tank, clean the plug and socket connector and spray with contact spray</p>
Engine will not reach full power	<p>Fuel supply partially interrupted</p> <p>Carburetors leaking</p> <p>Air filter very dirty</p> <p>The ignition curve for 80 octane is activated</p>	<p>Check the fuel taps, run the fuel lines without kinks</p> <p>Check vacuum hoses and venting hoses of carburetors for correct position (no kinks)</p> <p>Have the air filter replaced at an authorized KTM workshop.</p> <p>Activate the ignition curve for 95 octane, if fuel with 95 octane (ROZ) is being used</p>
Engine overheats	<p>Insufficient cooling liquid</p> <p>Radiator fins are extremely dirty</p> <p>Foam forms in cooling system</p> <p>Radiator hose is kinked or damaged</p> <p>Thermostat defective</p> <p>Blown fan fuse</p> <p>Defect fan or thermostwitch for fan</p>	<p>Refill cooling liquid (see maintenance work), check cooling system for leaks</p> <p>Clean radiator with water jet</p> <p>Replace cooling liquid, use antifreezer with brand name</p> <p>Run the radiator hose correctly or replace</p> <p>Have the thermostat checked (opening temperature 75°C, 167°F) or replaced; contact an authorized KTM workshop</p> <p>Replace fuse FAN</p> <p>Contact an authorized KTM workshop.</p>

TROUBLE	CAUSE	REMEDY
Engine does not rev up	EPC valve is mounted incorrectly and opens through vibrations	Check the position of the EPC valve (near the oil dipstick), it should not touch the frame
Engine stalls while driving	No fuel Operating error Fuse for fuel pump has blown	Refuel Open fuel taps Replace fuse FUEL PUMP
High oil consumption	Engine oil level too high Engine oil too thin (viscosity)	Check engine oil level when the engine is warm; correct if necessary Use thicker engine oil; see chapter „Engine oil“
Headlight and position light fail	Blown fuse	Replace fuse H/L BEAM POSITION.
Flasher lights, brake light, horn and multi-functional digital speedometer fail	Blown fuse	Replace fuse HORN BRAKELIGHT SPEEDO.
Time is not displayed or not correctly displayed	Blown fuse, thus no continuous power supply	Replace fuse CLOCK and set the clock.
The battery is discharged	The ignition (power consumer) hasn't been switched off The battery isn't charged by the generator because	Recharge the battery according to the relevant instructions. Remove left engine cowl and check brown cable connector on the voltage regulator, voltage regulator and generator should be checked by an authorized KTM workshop.
No values are visible in the multi-functional digital speedometer display.	Blown fuse	Replace fuse HORN BRAKELIGHT SPEEDO.
No speed display.	Defective sensor cable or oxidized socket connector.	Check the pickup cable for damage, remove the left panel and check the cable connector. Contact an authorized KTM workshop.

CLEANING

Regular cleansing and paintwork care is part of the maintenance work and helps to maintain the value of your motorcycle.



CAUTION



NEVER CLEAN YOUR MOTORCYCLE WITH A HIGH-PRESSURED CLEANER OR A HIGH-PRESSURED WATER JET. THE WATER COULD OTHERWISE RUN INTO THE ELECTRICAL COMPONENTS, CONNECTORS, SHEATHED CABLES, BEARINGS, CARBURETOR ETC. AND CAUSE DISTURBINGS OR LEAD TO A PREMATURE DESTRUCTION OF THESE PARTS.

- Before you wash your motorcycle, close the muffler openings.
- Use warm water with a commercial detergent and sponge. Coarse dirt can be removed with a soft water jet. Areas that are heavily soiled can be sprayed with a motorcycle cleaner (e.g. Motorex 900) and cleaned with a brush.
- After the motorcycle has been rinsed with a soft water jet, it should be dried by air pressure and a cloth. Then take a short drive until the engine has reached the working temperature and also use the brakes. Due to the heat, the water also evaporates at the unapproachable parts of the engine and the brakes.
- After the motorcycle has cooled down, oil or lubricate all of the friction bearings and bearing positions and treat the chain with chain spray. Treat all bare areas (except brake disks) with a corrosion inhibitor (e.g. Motorex Protect & Shine).
- The exhaust pipes can be polished with a chrome care product. The mufflers are made of stainless steel and should be treated with a suitable care product.
- Clean the windshield with plenty of water and a soft sponge. Chemical cleansers will corrode the plastic.
- To prevent failures in the electric system, you should treat the ignition lock, the emergency OFF switch, light switch and the socket connectors with contact spray.
- Treat all of the painted parts with a mild paint care product (e.g. Motorex Moto Polish).

CONSERVATION FOR WINTER OPERATION

In the event that the motorcycle is also used in winter and on roads where one has to expect salt spraying, you will have to take precautions against the aggressive road salt.

- clean motorcycle thoroughly and let it dry
- treat engine, carburetor, swing arm, and all other bare parts (except for brake discs) with a wax-based anti-corrosion agent.



WARNING



KEEP ANTI-CORROSION AGENT FROM GETTING INTO CONTACT WITH THE BRAKE DISCS, FOR OTHERWISE THIS WILL SIGNIFICANTLY REDUCE THE BRAKING POWER.



CAUTION



AFTER RIDES ON SALTED ROADS, CLEAN MOTORCYCLE THOROUGHLY WITH COLD WATER AND LET IT DRY WELL!

STORAGE

Should you desire to make a pause over a longer space of time, please observe the following instructions:

- Drive the tanks empty to be able to fill up with fresh fuel when starting the motorcycle up again.
- Clean motorcycle thoroughly (see chapter: CLEANING)
- Change engine oil and oil filter (old engine oil contains aggressive contaminations).
- Check antifreezer and amount of cooling liquid.
- Warm up the engine once again, close the fuel cock and wait until the engine dies. This drains the carburetor float chambers.
- Correct tire pressure.
- Disassemble and charge battery (see chapter: BATTERY).
- Jack up the motorcycle if possible so the wheels do not touch the ground.
- The storage place should be dry and not subject to excessive temperature fluctuations.
- Cover the motorcycle with an air permeated tarpaulin or blanket. Do not use non air permeable materials as a possible humidity might not be able to escape and could cause corrosion.



CAUTION



IT WOULD BE VERY BAD TO LET THE ENGINE RUN FOR A SHORT TIME DURING THE STORAGE PERIOD. THE ENGINE WOULD NOT GET WARMED UP ENOUGH AND THE THUS DEVELOPED STEAM WOULD CONDENSE DURING THE COMBUSTION PROCESS AND CAUSE THE VALVES AND EXHAUST TO RUST.

RE-INITIATION AFTER TIME OF STORAGE

- Mount the charged battery (regard polarity), secure the screws on the underride protection with Loctite 243.
- Fill up tank with fresh fuel.
- Check motorcycle as before each start (see driving instructions).
- Take a short, careful test ride first.

NOTE: Before you put your motorcycle away for the winter, you have to check all parts for their function and wear. Should any service jobs, repairs, or any refitting be necessary, you should have them carried out during the off-season (lower workload at mechanics' shops). This way, you can avoid the long waiting times at your mechanic at the beginning of the next biking season.

TECHNICAL SPECIFICATIONS CHASSIS – 950 ADVENTURE/ADVENTURE S 2004

950 ADVENTURE / 950 ADVENTURE S	
Frame	Tubular chrome-molybdenum-steel space frame
Fork	White Power – Up Side Down 4860 MXMA (Multiadjuster)
Spring travel front	ADVENTURE = 230 mm (9 in), ADVENTURE S = 265 mm (10.4 in)
Rear suspension	WP Progressive Damping System shock absorber with hydraulic preload adjuster nadelgelagerte Alu-Hinterradschwinge
Spring travel rear	ADVENTURE = 230 mm (9 in), ADVENTURE S = 265 mm (10.4 in)
Front brake	Disk brake, 2 perforated brake disks Ø 300 mm (10.8 in), floating brake calipers
Rear brake	Disk brake, perforated brake disk Ø 240 mm (9.5 in), floating brake caliper
Tires, front	Pirelli MT90 90/90-21 M/C 54V (Metzeler MCE Karoo 2 90/90-21 M/C 54R M+S max. 170 km/h, 105 mile/h)
Air pressure	road/driver only 2,4 bar (34 psi) road/with passenger 2,4 bar (34 psi)
Tires, rear	Pirelli MT90 150/70-18 M/C 70V (Metzeler MCE Karoo 150/70R18 M/C 70H M+S max. 170 km/h, 105 mile/h)
Air pressure	road/driver only 2,6 bar (37 psi) road/with passenger 2,8 bar (40 psi)
Fuel tank capacity	22 liters (5.8 USgal), 4 liters (1 USgal) reserve
Gear ratio – rear wheel	17:42
Chain	525 HV (5/8 x 5/16") X-ring, 118 rolls
Lighting	high beam H3 12V 55W (socket PK22s) low beam H7 12V 55W (socket PX26d) high beam + low beam H4 12V 60/55 W (socket P43t) (USA) position light front + rear 12V 5W (socket W2,1x9,5d) indicator lamp + Kontrollampen LED stoplight 12V 21W (socket BA15s) flasher 12V 10W (socket BA15s) licens plate illumination 12V 5W (socket W2,1x9,5d)
Battery	maintenance-free battery 12V 14 Ah
Steering head angle	63,4°
Wheel base	1590 mm (62.6 in)
Seat height, unloaded	ADVENTURE: 880 mm (34.6 in), ADVENTURE S: 915 mm (36 in)
Ground clearance, unloaded	ADVENTURE: 281 mm (11 in), ADVENTURE S: 316 mm (12,4 in)
Dry weight	206 kg (454.7 lbs)
Max. axle load, front	170 kg (357.3 lbs)
Max. axle load, rear	245 kg (540.8 lbs)
Max. total weight	400 kg (883 lbs)

STANDARD ADJUSTMENT FORK AND SHOCK ABSORBER

	950 ADVENTURE								950 ADVENTURE S							
	FORK				SHOCK ABSORB				FORK				SHOCK ABSORB			
	Driving Comfort	Basic Setting	Driving Sport	Maximum Payload	Driving Comfort	Basic Setting	Driving Sport	Maximum Payload	Driving Comfort	Basic Setting	Driving Sport	Maximum Payload	Driving Comfort	Basic Setting	Driving Sport	Maximum Payload
Compression damping (clicks)	20	15	15	15	-	-	-	-	20	15	15	15	-	-	-	-
Compr. damping low speed (clicks)	-	-	-	-	12	8	6	6	-	-	-	-	15	12	8	8
Compr. damping high speed (turns)	-	-	-	-	1,5	1,5	1	1	-	-	-	-	1,5	1,5	1	1
Rebound damping (clicks)	18	18	15	18	17	12	10	10	18	18	15	18	20	17	13	13
Spring preload (turns)	5	5	8	5	6	6	8	18	5	5	8	5	6	6	12	12

TIGHTENING TORQUES – CHASSIS		
HH clamp bolts on top triple clamp	M8	20 Nm
HH clamp bolts for steering stem	M8	20 Nm
HH clamp bolts on bottom triple clamp	M8	15 Nm
AH bolt for handlebar mount	M10	20 Nm
Collar bolts for handlebar clamps	M8	20 Nm
HH clamp bolts on fork legs	M8	10 Nm
Collar screw on front wheel spindle	M24x1.5	60 Nm
Collar nut wheel spindle rear	M25x1.5	110 Nm
Collar nut for swing arm bolt	M19x1.5	130 Nm
AH screw shock absorber top	M14x1.5	100 Nm
AH bolt shock absorber bottom	M14x1.5	Loctite 243 + 45 Nm
AH bolt for top of brake-hose guide	M6	Loctite 243 + 8 Nm
HH bolts on front brake caliper	M8	Loctite 243 + 25 Nm
HH bolts on footbrake cylinder	M6	Loctite 243 + 10 Nm
Collar bolt front brake disk	M6	Loctite 243 + 10 Nm
Collar bolt rear brake disks	M6	Loctite 243 + 10 Nm
AH bearing bolt for foot brake pedal	M8	Loctite 243 + 25 Nm
HH bolts on foot brake pedal surface	M5	Loctite 243 + 6 Nm
AH bolts on subframe	M10x1.25	Loctite 243 + 45 Nm
AH bolts on back of footrest support	M8	Loctite 243 + 25 Nm
AH bolts on tank cover	M5	5 Nm
HH bolt on fuel level indicator	M5	3 Nm
HH bolts fuel taps	M6	6 Nm
AH bolts on tank mounting	M8	25 Nm
Exhaust nuts on manifold	M8	evenly, do not bend sheet metal
HH bolts on exhaust suspension	M6	Loctite 243 + 12 Nm
Spoke nipple	M5	4 Nm
HH nuts on rear sprocket bolts	M10x1.25	Loctite 243 + 50 Nm
Hexagon nut on engine sprocket	M20x1.5	sheet retainer + 100 Nm
Engine carrier bolts	M10	45 Nm
HH bolts for side stand bracket - engine	M10	Loctite 243 + 45 Nm
HH bolts side stand bracket - side stand console	M10	Loctite 243 + 25 Nm
HH bolts side stand mounting	M10	Loctite 243 + 45 Nm
HH bolt spring retainer side stand	M8	Loctite 243 + 25 Nm
HH bolt side stand switch	M6	Loctite 243 + 10 Nm
HH bolts for underride protection	M8	Loctite 243 + 25 Nm
Drain plug on oil tank	M12x1.5	20 Nm
Other bolts on chassis	M6	10 Nm
	M8	25 Nm
	M10	45 Nm
Other collar nuts on chassis	M6	15 Nm
	M8	30 Nm
	M10	50 Nm

TECHNICAL SPECIFICATIONS ENGINE – LC8 2004

Engine	950 LC8
Design	Liquid-cooled, 2-cylinder 4-stroke engine with 75° V arrangement with balancer shaft and electric starter
Displacement	942 ccm
Bore / Stroke	100/60 mm
Compression ratio	11.5:1
Fuel	unleaded premium fuel with at least RON 95 (ROZ 80 - 94 for other ignition curve)
Valve timing	4 valves controlled over bucket tappet and 2 camshafts, camshaft drive with gears/chain
Valve diameter	Intake: 38 mm Exhaust: 33 mm
Valve clearance, cold	Intake: 0,15 mm Exhaust: 0,25 mm
Crankcase bearing	Friction bearings (2 main bearings / 1 supporting bearing)
Conrod bearing	Friction bearing
Piston pin bearing	Dual-fuel bearing
Piston	Light alloy – forged
Piston rings	1 compression ring, 1 taper face ring, 1 single-piece oil scraper ring with spiral-type expander
Engine lubrication	Dry sump with 2 trochoidal pumps (pressure pump and suction pump)
Engine oil	SAE 5W/40, 10W/50 (Motorex Power Synt 4T) #
Quantity of engine oil	approx. 3.0 liters during oil/filter change
Primary drive	Straight-toothed spur wheels 67 : 35
Clutch	Multi-disc clutch in oil bath
Transmission	6-speed claw shifted
Gear ratio	1st gear 35:12 2nd gear 32:15 3rd gear 30:18 4th gear 27:20 5th gear 27:24 6th gear 26:27
Ignition system	breakerless transistorized electronic ignition system with digital ignition advance
Ignition timing	5° from TDC at 1200 rpm
Generator	12V 450W at 6000 rpm
Spark plug	NGK CR 8 EK
Electrode distance	0.6 mm
Cooling system	liquid cooled, permanent circulation of cooling liquid through water pump
Cooling liquid	2.1 liters, 40% antifreeze, 60% water, at least –25° C
Starting aid	0.9 kW electric starter

#

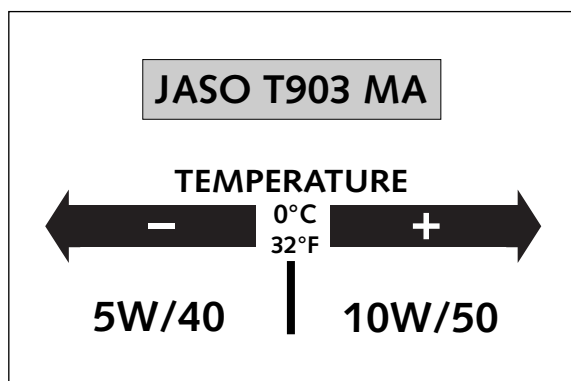

Engine oil

Only use fully synthetic engine oils that meet the JASO MA quality requirements (see information on the can).

KTM recommends Motorex Power Synt 4T in the 10W/50 viscosity (for temperatures over 0°C, 32°F) or 5W/40 (for temperatures under 0°C, 32°F).

BASIC CARBURETOR SETTING

	950 LC8 ADVENTURE
Type of carburetor	CVRD 43
Main jet	155 (front) / 160 (rear)
Main air jet	40
Idling jet	42
Idle air jet	50
Idle air cutoff jet	80
Jet needle	NDFB
Needle position	2nd from top
Mixture control screw open	2 1/4 turns
Starting jet	68

TIGHTENING TORQUES – ENGINE		
Hexagon nut on primary gear	M33x1.5 left	Loctite 243 + 130 Nm
Multipoint head bolt on conrod caps	M10x1	25 Nm / 30Nm / 60°
Hexagon nut on balancer shaft	M20x1.5	Loctite 243 + 150 Nm
Hexagon nut on cylinder head	M10	25 Nm / 46 Nm
AH bolts on cylinder head	M8	18 Nm / 23 Nm
Hexagon nut on cylinder head	M6	8 Nm
Studs in engine case	M6	10 Nm
Studs in engine case	M10	20 Nm
Stud on exhaust flange	M8	15 Nm
Plug on front cylinder head	M12x1.5	15 Nm
Screws to attach bearings	M5	Loctite 243 + 6 Nm
Crankshaft locking bolt	M8	10 Nm
Bearing bolts on tensioning rail	M8	Loctite 243 + 20 Nm
Bearing bolts on guide rail	M8	Loctite 243 + 15 Nm
Bearing bolts on double timing gear	M10	30 Nm
Bolt on chain tensioner	M16x1.5	20 Nm
AH bolts on camshaft bearing bridges	M8 10.9	10 Nm / 18 Nm
AH bolts on camshaft bearing bridges	M6 10.9	10 Nm
HH bolts on valve covers	M6	10 Nm
HH bolts on engine case halves	M6	10 Nm
HH bolts on engine case halves	M8	20 Nm
AH bolts on freewheel support	M6 10.9	Loctite 648 + 13 Nm
HH screws on freewheel holder	M6	Loctite 243 + 10 Nm
Oil plug (clutch lubrication)	M10	15 Nm
Oil drain plug	M22x1.5	20 Nm
Oil line screw connections	M6	10 Nm
HH bolts on oil pump cover	M6	Loctite 243 + 10 Nm
Plug on oil filter housing	M14x1.5	Loctite 243 + 15 Nm
Oil jets	M6x0.75	Loctite 243 + 10 Nm
Oil pressure switch	M10x1	10 Nm
AH bolt on shift locating drum	M6	Loctite 243 + 10 Nm
HH bolt on shift locking lever	M5	Loctite 243 + 8 Nm
HH bolt on the shift lever	M6 10.9	Loctite 243 + 18 Nm
Hexagon nut on clutch clutch hub	M22x1.5	Loctite 243 + 130 Nm
HH bolts on clutch pressure cap	M6	10 Nm
HH bolt on clutch cover	M6	10 Nm
HH bolt on clutch cover	M8	15 Nm
HH bolt on outer clutch cover	M6	10 Nm
AH bolt on ignition rotor	M16	Loctite 243 + 150 Nm
HH bolt on generator cover	M6	10 Nm
Fixing bolts on the stator	M6	Loctite 243 + 10 Nm
Plug on generator cover	M24x1.5	8 Nm
Bleeder flange on generator cover	M16x1.5	Loctite 243 + 10 Nm
Bearing bolt on generator cover	M6	Loctite 243 + 10 Nm
Fixing bolts on ignition pickup	M6	Loctite 243 + 10 Nm
HH screws on gear sensor	M5	4 Nm
Spark plugs	M10x1.0	12 Nm
Collar bolt on water pump wheel	M6	Loctite 243 + 10 Nm
HH bolt on water pump cover	M6	10 Nm
Water temperature sensor	M12x1.5	12 Nm
Water connections for cylinder head	M20x1.5	Loctite 577 + 10 Nm
HH bolt on the starter motor	M6	10 Nm
Vacuum connections for intake port	M6	Loctite 243 + 8 Nm
Hexagon nut on chain sprocket	M20x1.5	sheet retainer + 100 Nm
Other engine bolts	M5	6 Nm
	M6	10 Nm

HEAD WORD INDEX

	Page		Page
Accessories and payload	.14	Filler caps	.10
Activating the ignition curve for low-octane fuel	.43	Foot brake pedal	.11
Adjusting compression damping of fork	.23	Footrests	.13
Adjusting of free travel at the hand brake lever	.28	Fuel	.18
Adjusting rebound damping of fork	.23	Fuel taps	.10
Adjusting the engine idle speed	.39	Fuses for individual current consumers	.34
Adjusting the fork and shock absorber	.23	General informations about KTM disc brakes	.27
Adjusting the headlight range	.36	General tips and warnings for starting the motorcycle	.14
Adjusting the preload of the shock absorber	.25	Grips	.13
Adjusting the spring preload on the fork	.23	Hand brake lever	.5
Baggage carrier plate	.13	Ignition lock	.9
Battery	.32	Indicator lamps	.8
Braking	.17	Instructions for initial operation	.14
Breathing the fork legs	.25	Main fuse	.34
Center stand	.11	Maintenance work on chassis and engine	.22
Chain maintenance	.26	Multi-functional digital speedometer	.6
Changing the basic position of the foot brake lever	.29	Operation instruments	.5
Changing the engine oil and the oil filter, cleaning the oil screen	.40	Periodic maintenance schedule	.20
Changing the original position of the clutch lever	.38	Re-initiation after time of storage	.46
Charging the battery	.33	Rebound damping of fork	.12
Chassis number	.5	Rebound damping of shock absorber	.24
Check the following before each start	.15	Rebound damping of shock absorber	.12
Checking and adjusting the choke cable play	.39	Refilling the front brake fluid reservoir	.28
Checking and adjusting the throttle cable play	.38	Refilling the rear brake fluid reservoir	.29
Checking of brake fluid level - front brake	.28	Removing and remounting the seat	.22
Checking rear brake fluid level	.29	Replacing the brake and tail light bulbs	.36
Checking spoke tension	.32	Replacing the flasher bulbs	.36
Checking the chain for wear	.26	Replacing the headlight lamps	.35
Checking the chain tension	.25	Running in the LC8 engine	.14
Checking the cooling liquid level in the compensating tank	.37	Seat lock	.10
Checking the cooling liquid level in the radiator	.38	Serial number locations	.5
Checking the engine oil level	.39	Setting options in the display	.7
Checking the front brake pads	.28	Shift lever	.11
Checking the oil level of the hydraulic clutch	.38	Shifting/Riding	.17
Checking the rear brake pads	.29	Shock absorber's preload adjuster	.13
Checking the shock absorption rubbers in the rear hub	.31	Side stand	.11
Choke lever	.5	Spring preload of the fork	.12
Cleaning	.46	Starting off	.17
Cleaning the dust sleeves of the telescopic fork	.25	Starting when the engine is cold	.16
Clutch lever	.5	Starting when the engine is warm or hot	.16
Combination switch	.9	Stopping and parking	.17
Compression damping of fork	.11	Storage	.46
Compression damping of shock absorber	.24	Storage compartment	.10
Connecting the battery jumper cable	.33	Tachometer	.8
Conservation for winter operation	.46	Technical specifications - chassis	.47
Consumer information USA only	.appendix	Technical specifications - engine	.49
Cooling liquid temperature display	.8	Tires, air pressure	.32
Cooling system	.37	Tool set	.22
Correct chain tension	.26	Trouble shooting	.44
Damping action during compression of shock absorber	.12	Wiring diagram	.appendix
Demounting and mounting the battery	.33		
Demounting and mounting the front wheel	.30		
Demounting and mounting the rear wheel	.31		
Display	.6		
Driving instructions	.15		
Emergency OFF tip switch, light switch, starter tip switch	.9		
Engine number, engine type	.5		
Engine oil	.39		

CONSUMER INFORMATION FOR USA ONLY

REPORTING SAFETY DEFECTS

If you believe that your vehicle has a defect which could cause a crash or could cause injury or death, you should immediately inform the National Highway Traffic Safety Administration (NHTSA) in addition to notifying KTM Sportmotorcycle USA, Inc.

If NHTSA receives similar complaints, it may open an investigation, and if it finds that a safety defect exists in a group of vehicles, it may order a recall and remedy campaign. However, NHTSA cannot become involved in individual problems between you, your dealer, or KTM Sportmotorcycle USA Inc.

To contact NHTSA, you may either call the Auto Safety Hotline toll-free at 1-800-424-9393 (or 366-0123) in Washington D.C. area) or write to: NHTSA, U.S. Department of Transportation, Washington, D.C. 20590. You can also obtain other information about motor vehicle safety from the Hotline.

NOISE EMISSION WARRANTY

KTM Sportmotorcycle AG warrants that this exhaust system, at the time of sale, meets all applicable U.S. EPA Federal noise standards. This warranty extends to the first person who buys this exhaust system for purposes other than resale, and to all subsequent buyers.

Warranty claims should be directed to:

KTM Sportmotorcycle USA Inc. 1119 Milan Avenue,
Amherst, Ohio 44001, Telephone: (440) 9853553

TAMPERING WARNING:

TAMPERING WITH NOISE CONTROL SYSTEM PROHIBITED. FEDERAL LAW PROHIBITS THE FOLLOWING ACTS OR CAUSING THEREOF:

- (1) The removal or rendering inoperative by any person other than for purposes of maintenance, repair, or replacement, of any device or element of design incorporated into any new vehicle for the purpose of noise control prior to its sale or delivery to the ultimate purchaser or while it is in use, or
- (2) the use of the vehicle after such device or element of design has been removed or rendered inoperative by any person.

AMONG THOSE ACTS PRESUMED TO CONSTITUTE TAMPERING ARE THE ACTS LISTED BELOW.

- 1) Removal of, or puncturing the muffler, baffles, header pipes or any other components which conducts exhaust gases.
- 2) Removal or puncturing of any part of the intake system.
- 3) Lack of proper maintenance.
- 4) Replacing any moving part of the vehicle, or parts of the exhaust or intake system, with parts other than those specified by the manufacturer.

WARNING STATEMENT:

This product should be checked for repair or replacement if the motorcycle noise has increased significantly through use. Otherwise, the owner may become subject to penalties under state and local ordinances.

KTM 950 ADVENTURE 2004 USA

ACHTUNG

Lesen Sie vor der ersten Inbetriebnahme des Motorrades die gesamte Bedienungsanleitung aufmerksam durch!

IMPORTANT

Before you get the first ride on the motorbike, read the entire User's Guide carefully!

ATTENZIONE

Prima della prima messa in servizio del motociclo, leggere attentamente L'intero manuale d'uso.

ATTENTION

Il convient de lire attentivement tout le manuel d'utilisation avant la première mise en service!

ATENCIÓN

Leer atentamente todas las instrucciones para el servicio antes de la primera puesta en marcha de la motocicleta!

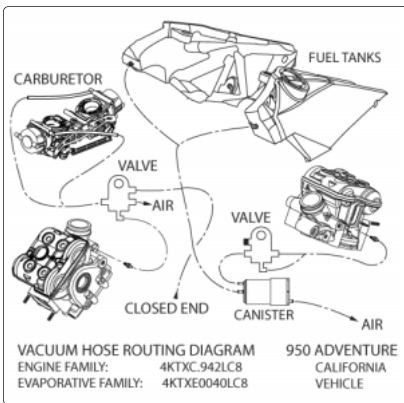

KTM SPORTMOTORCYCLE AG, MATTIGHOFEN, AUSTRIA			
VEHICLE EMISSION CONTROL INFORMATION			
ENGINE FAMILY	4KTXC.942LC8	EVAPORATIVE FAMILY	4KTXE0040LC8
DISPLACEMENT	942cm ³	EXHAUST EMISSION CONTROL SYSTEM	TWC
ENGINE TUNE-UP SPECIFICATIONS AND ADJUSTMENTS:		N.A.	
ITEM	SPEC	SPEC	
1. IGNITION TIMING	5° BTDC(1400/RPM)	42° BTDC(8000/RPM)	
2. IDLE SPEED (RPM)	1400		
3. IDLE MIXTURE	NON-ADJUSTABLE		
4. VALVE CLEARANCE (MM) IN	0,15	EX 0,25	
5. SPARK PLUG	NGK CR8EK	SPARK PLUG GAP (MM)	0,7
FUEL SPECIFICATIONS		ENGINE LUBRICANT SPECIFICATIONS	
GASOLINE GRADE	UNLEADED	ENGINE OIL	3,5 LITRES (Incl.OIL-TANK)
RESEARCH OCTANE	95	TYPE	SAE 15W/40
THIS VEHICLE CONFORMS TO U.S. EPA AND CALIFORNIA REGULATIONS APPLICABLE TO 2004 MODEL YEAR NEW MOTORCYCLES AND IS CERTIFIED TO 1,4 g/km HC+NOX EMISSION STANDARD IN CALIFORNIA.			
MADE IN AUSTRIA			950 ADVENTURE

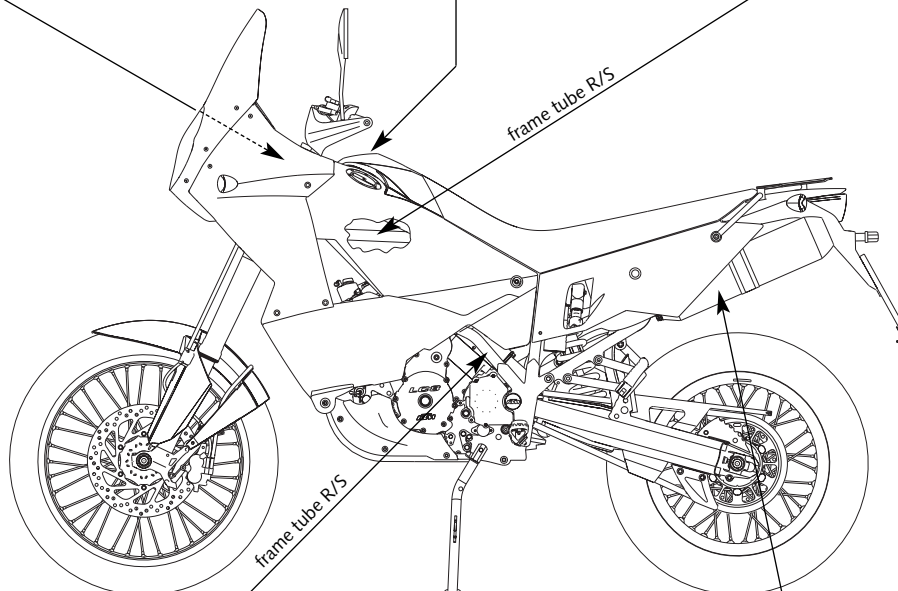

MOTORCYCLE NOISE EMISSION CONTROL INFORMATION
THIS 2004 KTM4210942 MOTORCYCLE MEETS EPA NOISE EMISSION REQUIREMENTS OF 80 dBA AT 4250 RPM BY THE FEDERAL TEST PROCEDURE. MODIFICATION WHICH CAUSE THIS MOTORCYCLE TO EXCEED FEDERAL NOISE STANDARDS ARE PROHIBITED BY FEDERAL LAW. SEE OWNER'S MANUAL. 950 ADVENTURE
KTM SPORTMOTORCYCLE AG, AUSTRIA

THIS KTM EXHAUST SYSTEM 600.05.083.000 MEETS EPA NOISE EMISSION REQUIREMENTS OF 80 dBA FOR MODEL SPECIFIC CODE KTM 4210942. INSTALLATION OF THIS EXHAUST SYSTEM ON MOTORCYCLES NOT SPECIFIED MAY VIOLATE FEDERAL LAW.



950-Adventure 03/04

wiring diagram

front - 600 11 075 000
rear - 600 11 076 000

oil pressure switch -
600 11 092 000

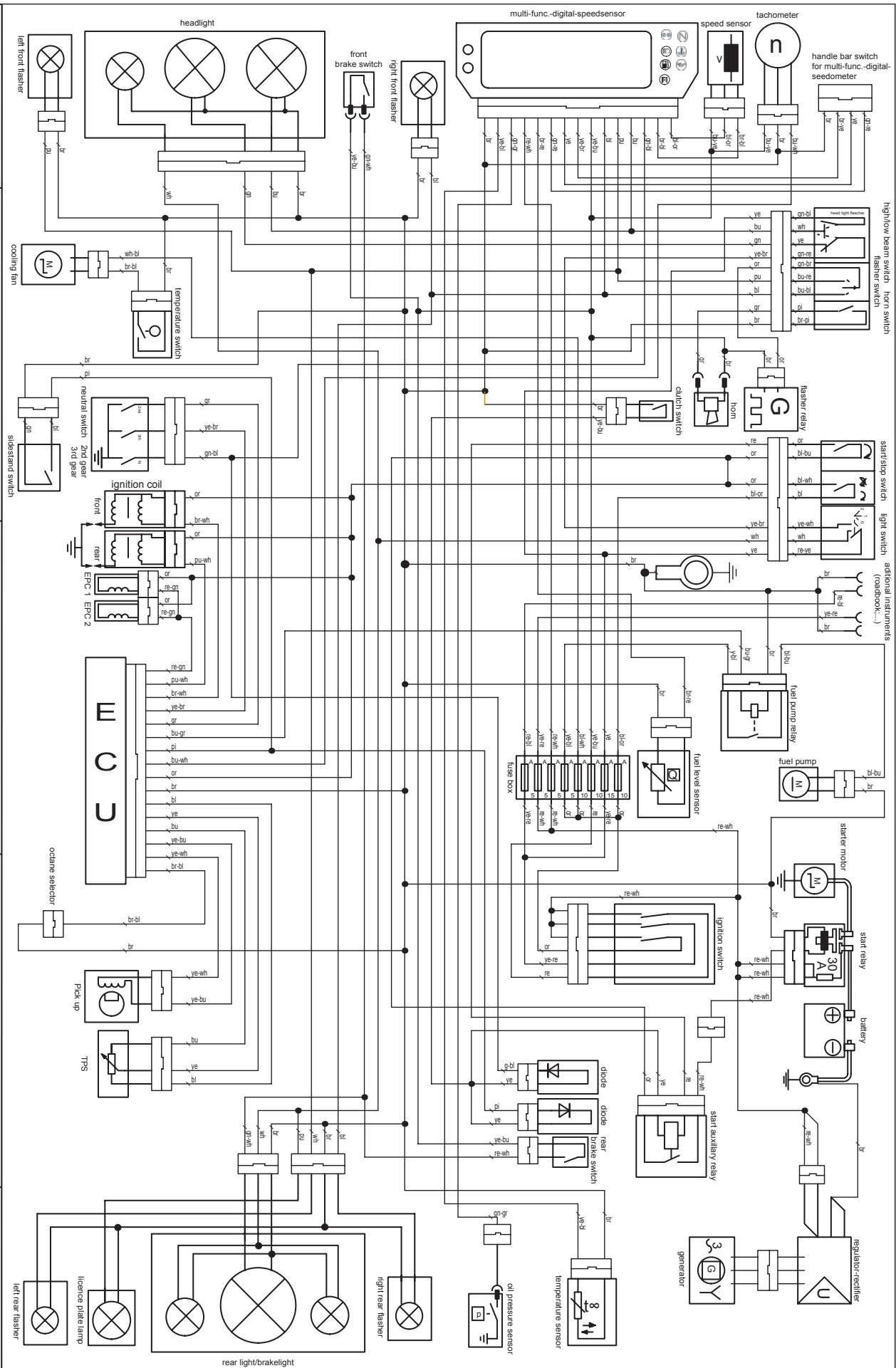

ENGLISH	DEUTSCH	ITALIANO
Additional instruments (roadbook;...)	Externe Instrumente	Strumenti supplementari
Battery	Batterie	Batteria
Clutch switch	Kupplungsschalter	Interruttore frizione
Cooling fan	Lüftermotor	Motorino ventola
Diode	Diode	Diodo
Flasher relay	Blinkerrelais	Relè indicatori
Flasher switch	Blinkerschalter	Deviatore indicatori di direzione
Front brake switch	vorderer Bremslichtschalter	Interruttore luce ant. di stop
Fuel level sensor	Benzinstandgeber	Sensore livello benzina
Fuel pump	Kraftstoffpumpe	Pompa benzina
Fuel pump relay	Kraftstoffpumpenrelais	Relè pompa benzina
Fuse box	Sicherungskasten	Scatola fusibili
Gear sensor	Gangerkennung	Sensore marce
Generator	Generator	Generatore
Handle bar switch for multi-func.-digital-speedometer	Lenkerschalter für Kombiinstrument	Interruttore sul manubrio per tachimetro multifunzione
Headlight	Scheinwerfer	Faro anteriore
High / low beam switch	Auf-Abblendschalter	Commutatore abbagliante/anabbagliante
Horn	Hupe	Avvisatore acustico
Horn switch	Hornschalter	Interruttore avvisatore acustico
Ignition coil	Zündspule	Bobina d'accensione
Ignition switch	Zündschloss	Interruttore d'accensione
Left front flasher	linker vorderer Blinker	Indicatore ant. sx
Left rear flasher	linker hinterer Blinker	Indicatore post. sx
Licence plate lamp	Kennzeichenbeleuchtung	Luce targa
Light switch	Lichtschalter	Deviatore luci
Multi-func.-digital-speedometer	Multifunktionsdigitaltacho	Tachimetro digitale multifunzione
Neutral switch	Leerlaufschalter	Interruttore folle
Octane selector	Oktanangepassung	Adattamento anticipo agli ottano
Oil pressure sensor	Öldruckschalter	Pressostato olio
Pick up	Impulsgeber	Pick up
Rear brake switch	hinterer Bremslichtschalter	Interruttore luce post. di stop
Rear light / brakelight	hinteres Begrenzungslicht / Bremslicht	Luce post. di posizione/stop
Regulator-rectifier	Regelgleichrichter	Regolatore-raddrizzatore
Right front flasher	rechter vorderer Blinker	Indicatore ant. dx
Right rear flasher	Rechter hinterer Blinker	Indicatore post. dx
Sidestand switch	Seitenständerschalter	Interruttore cavalletto lat.
Speed sensor	Geschwindigkeitssensor	Sensore velocità
Start auxillary relay	Starterhilfsrelais	Relè ausiliario d'avviamento
Start relay	Startrelais	Relè d'avviamento
Start/stop switch	Start / stop schalter	Interruttore combinato d'avviamento e d'emergenza
Starter motor	Startermotor	Motorino d'avviamento
Tachometer	Drehzahlmesser	Contagiri
Temperature sensor	Temperatursensor	Sensore temperatura
Temperature switch	Temperaturschalter	Interruttore termico
Throttle position sensor (TPS)	Vergaserpotentiometer	Potenziometro carburatore (sensore TPS)

Cable colours

bl: black
ye: yellow
bu: blue
gr: green
re: red
wh: white
br: brown
or: orange
pi: pink
gr: grey
pu: purple

Kabelfarben

bl: blau
ye: gelb
bu: blau
gr: grün
re: rot
wh: weiß
br: braun
or: orange
pi: rosa
gr: grau
pu: violett

Cavo colorato

bl: nero
ye: giallo
bu: blu
gr: verde
re: rosso
wh: bianco
br: marrone
or: arancione
pi: rosa
gr: grigio
pu: violetto



KTM Group Partner



KTM Sportmotorcycle AG
A-5230 Mattighofen
www.ktm.at